

Bell 206B3

Bell
Helicopter
A Textron Company

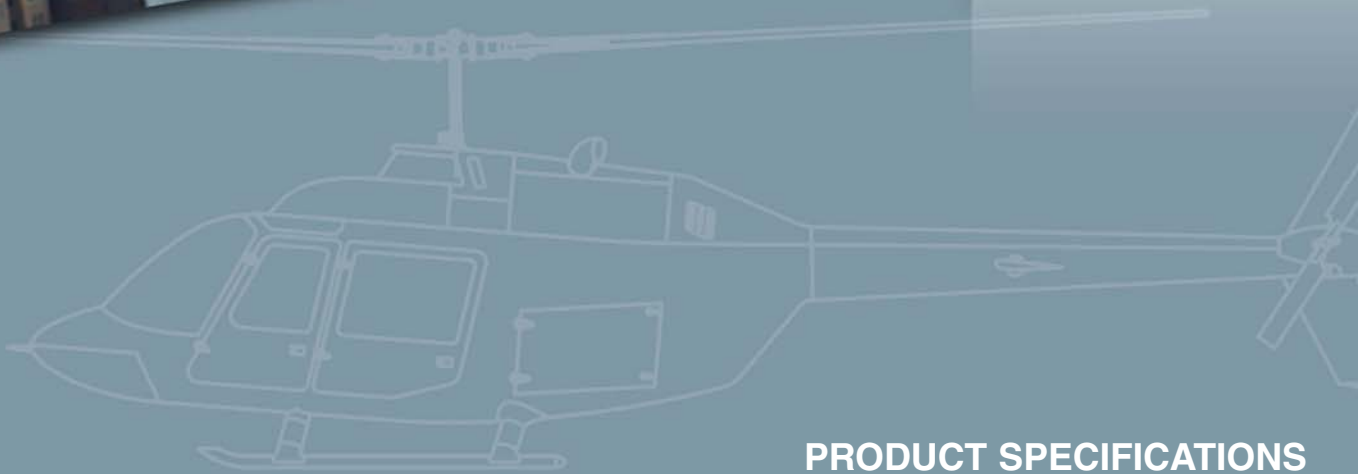

SPECIFICATIONS



PRODUCT SPECIFICATIONS
JANUARY 2005

For additional information visit the Bell Helicopter Textron Website

Homepage: www.bellhelicopter.com

Sales Contact Telephone Numbers

Sales Inquiries

U.S. Toll Free: 800-FLY-BELL

International/US: 817-280-2800

Email: marketing@bellhelicopter.textron.com

Regional Sales Managers

US/Canada 817-280-3601

Asia Pacific 817-280-2197

Europe/Middle East/Africa 817-280-3261

Latin America 817-280-2713

Fax: 817-280-5037

Marketing Home Office

Bell Helicopter Textron Inc.

Plant 8, Bldg 40

POB 482

Fort Worth, TX 76101-0482

marketing@bellhelicopter.textron.com

Manufacturing Facility

Bell Helicopter Textron Canada Inc

12,800 rue de l'Avenir

Mirabel, Quebec

Canada J7J 1R4

Fax: 450-437-2006

This book was produced by



Visual Communications Center

POB 482

Ft Worth, TX 76101-0482



PUBLISHERS NOTICE

The data presented in this document is general in nature, and has been compiled from Bell Helicopter Textron, Inc. [BHTI] source materials including but not limited to; The Approved Rotorcraft Flight Manual, Maintenance Manual, Illustrated Parts Catalog, and other engineering design specifications.

This document is intended for the use of **BHTI Sales Personnel** and for **prospective customers** as an aid in determining estimated weight and performance of the helicopter when configured with equipment for specific missions.

Disclosure, reproduction, or use of any material in this document by persons other than BHTI employees, and BHTI independent representatives [International Dealers] is **forbidden** without written permission from Bell Helicopter Textron.

The Part Numbers of Optional Equipment [KITS] are subject to revision and change, and also may be different for specific serial number helicopters or special custom configurations. Please consult the *NOTES* found in the right margins of the optional equipment list pages for **equipment compatibility**. The continuing product improvement process of BHTI may cause some components, equipment, and compatibility to be changed or replaced.

The SPECIFICATIONS, WEIGHTS, DIMENSIONS, AND PERFORMANCE DATA shown in this document are subject to change without notice.

©Copyright, Bell Helicopter Textron, Inc., 2005

®™, Bell Helicopter, Bell Helicopter Textron Inc., Bell 206B3, 206L-4, 407, 427, 430, 412, 609, JetRanger and LongRanger are registered trademarks of Bell Helicopter Textron Inc.



EXTERIOR DIMENSIONS STANDARD LOW SKID GEAR

206B3
STD GEAR

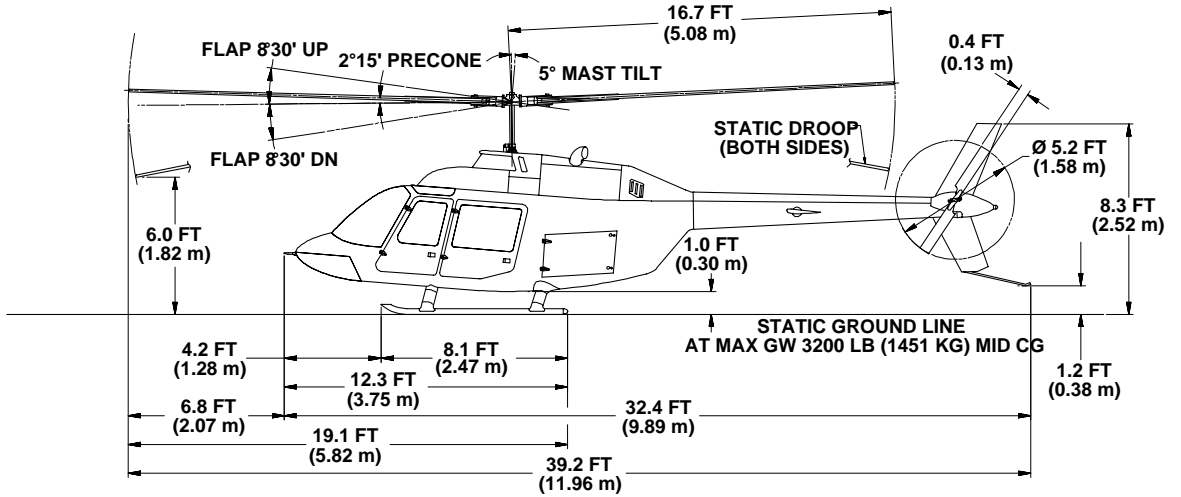
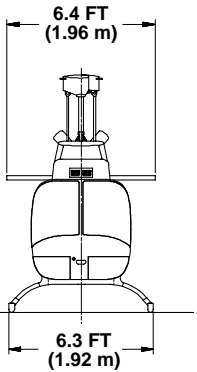
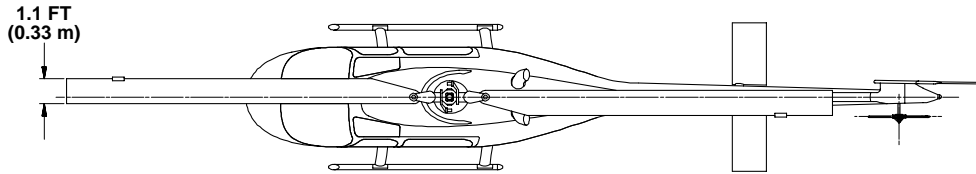

OPTIONAL HIGH SKID GEAR w/AAI FLIGHTSTEP®

206B3
HIGH SKID GEAR

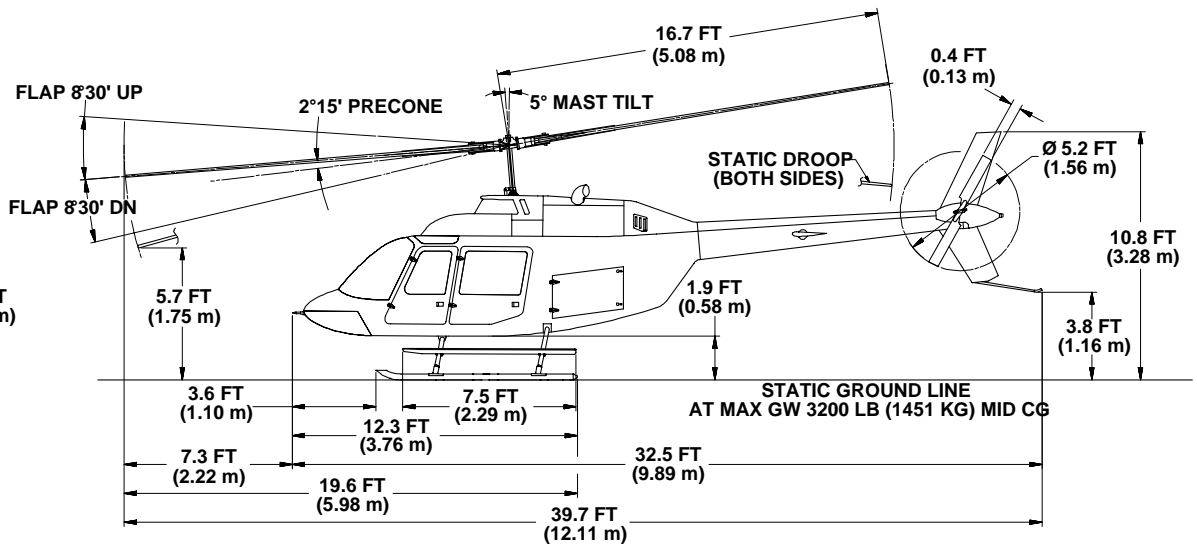
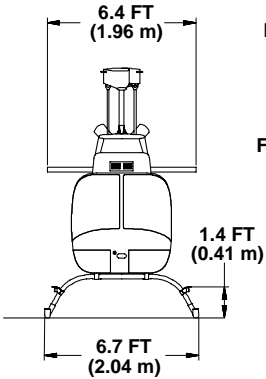
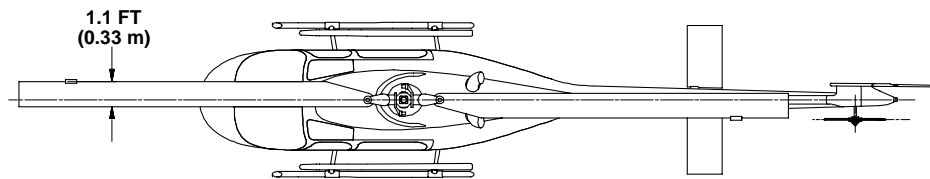



OPTIONAL EMERGENCY FLOAT GEAR w/ AAI FLOATSTEP®

206B3
FLOAT KIT

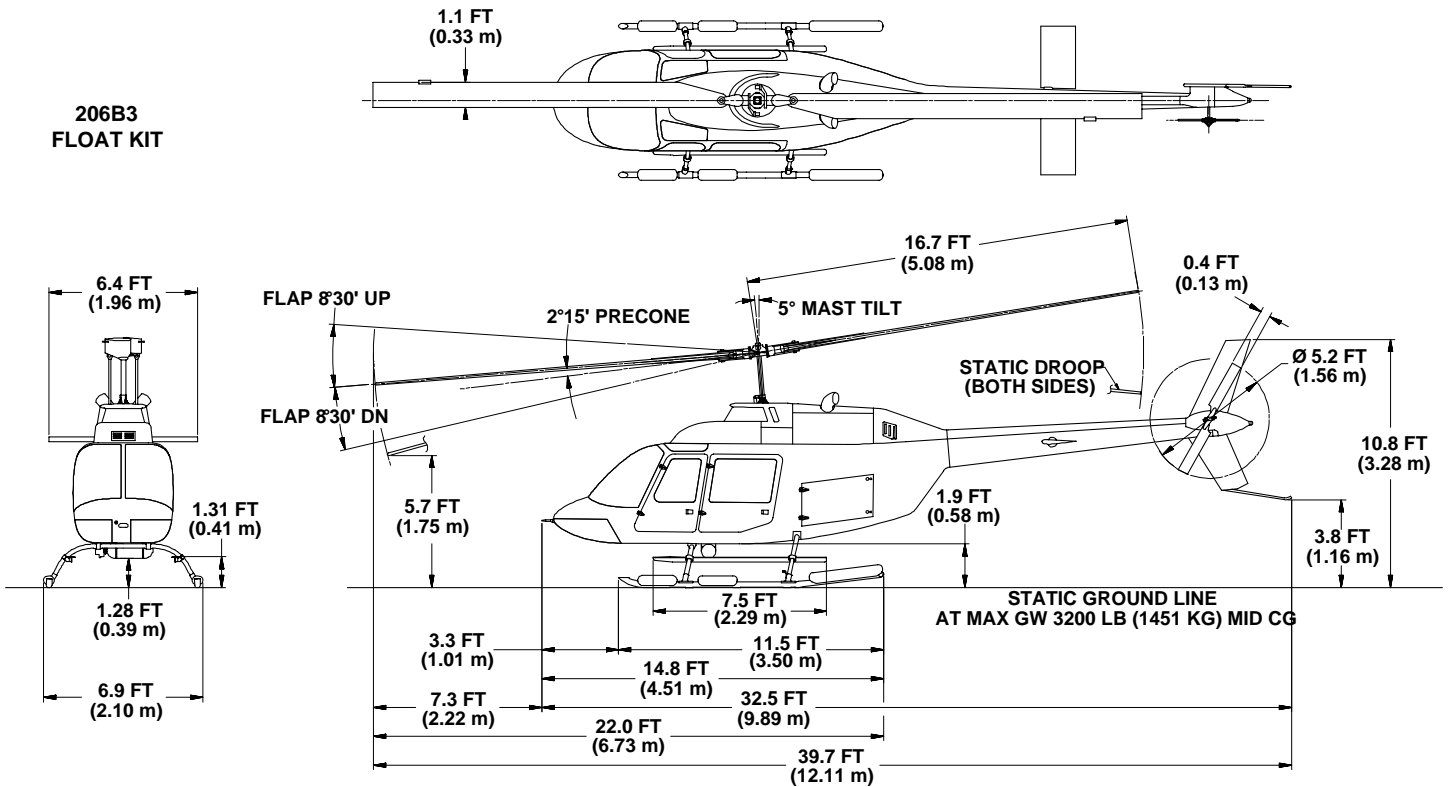

MINIMUM HANGAR SIZE*
7.0 FT X 40.0 FT
[2.2 M X 12.2 M]

*ALLOWANCE SHOULD BE MADE FOR HIGH SKID GEAR,
 GROUND WHEELS, EMPTY FUEL CONDITION, AND DOOR LIP
 WHEN CONSIDERING HANGAR DOOR WIDTH AND HEIGHT



INTERNAL DIMENSIONS

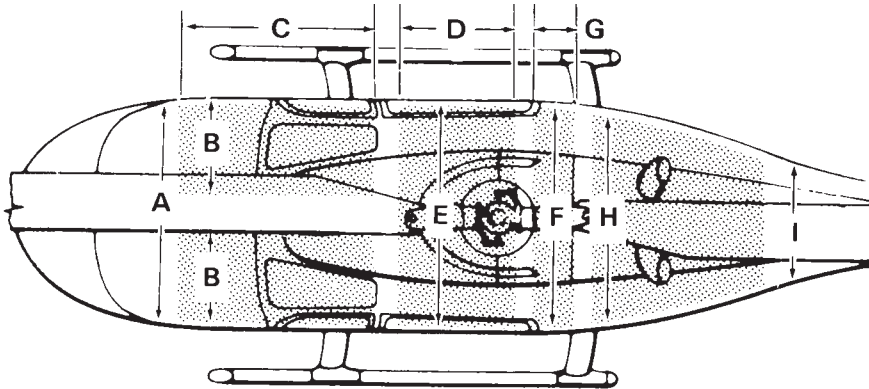

		Meters	Feet	
Passenger compartment Approximately 1.12 cubic meters (40 cubic feet).	A.	Forward Cabin Width	1.22	4.0
	B.	Forward Seat — Width (each)	0.38	1.3
	C.	Forward Seat & Leg Room	1.09	3.6
	D.	Aft Seat & Leg Room	0.99	3.3
	E.	Aft Seat — Width	1.19	3.9
	F.	Baggage Shelf — Width	1.04	3.4
	G.	Baggage Shelf — Depth	0.25	0.8
	H.	Baggage Compartment — Fwd Width	1.04	3.4
	I.	Baggage Compartment — Aft Width	0.48	1.6
Passenger and baggage compartments Loading up to 420 kilograms per square meter (86 pounds per square foot).				

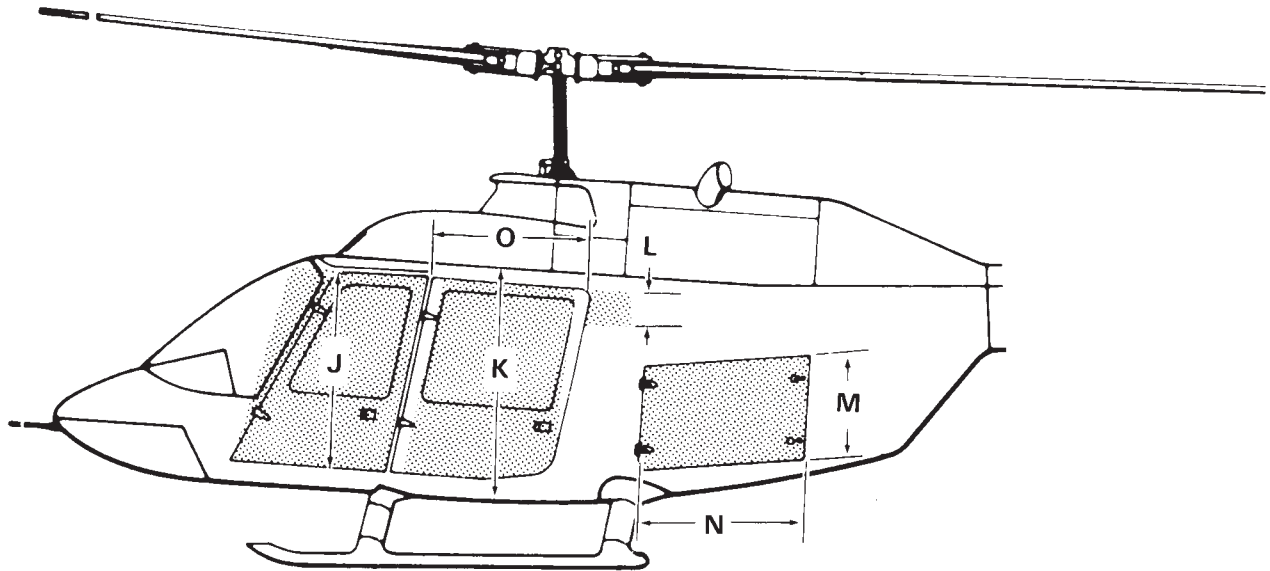

		Meters	Feet	
Baggage compartment 0.45 cubic meters (16 cubic feet).	J.	Door Opening Height	1.14	3.8
	K.	Ceiling to Floor	1.30	4.3
	L.	Baggage Shelf Height	0.38	1.3
	M.	Baggage Compartment — Height	0.56	1.8
	N.	Baggage Compartment — Length	0.91	3.0
	O.	Aft Door Opening — Width	0.89	2.9



LEFT BLANK



SPECIFICATION SUMMARY[U. S. Units]

[Serial No. 4584 & Subsequent]

<u>WEIGHTS</u>	<u>LBS</u>
Standard Configuration Weight (Note 1)	1713
Internal Gross Weight [Normal/Optional] (*Note 2)	3200/3350*
External Load Gross Weight	3350
Useful Load (Gross Wt.-Standard Config. Wt.) [Normal/Optional] (*Note 2)	1487/1637*
Maximum External Load (Cargo Hook Limit)	1500

Note 1: Includes twelve (12.0) pounds of engine oil. **Ballast** is not included in standard configuration weight (ballast is a function of installed equipment).

PERFORMANCE SUMMARY: (International Standard Day Except as Noted)

••• REFER TO DEMONSTRATED TAKEOFF & LANDING AND MAXIMUM OPERATING ALTITUDE NOTES ON THE PERFORMANCE CHARTS •••

<u>TAKEOFF GROSS WEIGHT</u>		<u>LBS</u>	<u>2600</u>	<u>3000</u>	<u>3200</u>	<u>3350</u>
IGE Hovering Ceiling	ISA	ft	19,600	15,200	13,200	11,800*
(2 ft skid height)	ISA+20C	ft	16,800	12,300	10,200	8800*
OGE Hovering Ceiling	ISA	ft	14,900	10,300	5300	(3350lbs@SL)*
	ISA+20C	ft	11,800	7200	3000	(3280lbs@SL)*
Certificated Altitude	ISA	ft	20,000	20,000	13,500	13,500*
Service Ceiling (MCP)	ISA	ft	20,000+	18,200	13,500	13,500*
(100 ft/min)						
Sea Level Max R/C (TOP)	ISA	ft/min	1940	1525	1350	1230*
Maximum Allowable IAS	ISA, SL	kn	130	130	122	78*
	ISA, 5000ft	kn	124	124	108	78*
MCP True Airspeed	ISA, SL	kn	121	118	115	77*
@ Takeoff GW	ISA, 5000ft	kn	128	122	115	83*
Range @ LRC speed	ISA, SL	nm	389	382	374	360*
(Avg. GW, Full Fuel)	ISA, 5000ft	nm	452	432	420	403*
Endurance @ Loiter 52 kn	ISA, SL	hr	4.7	4.6	4.5	4.4*
(No Reserve)						

Note 2: Operation at Internal Gross Weight above 3200 pounds requires the Optional STC Increased Internal Gross Weight to 3350 pounds Kit (FMS-37).

ENGINE POWER RATINGS:

(**STANDARD** Rolls-Royce 250-C20J) Uninstalled Mechanical Rating

Takeoff , SHP	420
Maximum Continuous, SHP	370

TRANSMISSION RATINGS:

Takeoff , SHP	317
Maximum Continuous, SHP	270

FUEL:

Type	Aviation Turbine
Capacity (Usable)	91 Gallons

THE DATA SET FORTH ON THIS DOCUMENT ARE GENERAL IN NATURE AND MAY VARY WITH CONDITIONS. FOR PERFORMANCE DATA AND OPERATING LIMITATIONS FOR ANY SPECIFIC FLIGHT MISSION, REFERENCE MUST BE MADE TO THE APPROVED FLIGHT MANUAL.

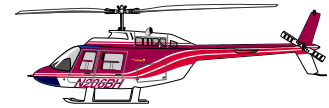

SPECIFICATION SUMMARY[Metric Units]

[Serial No. 4584 & Subsequent]

<u>WEIGHTS</u>	<u>KG</u>
Standard Configuration Weight (Note 1)	777
Internal Gross Weight [Normal/Optional] (*Note 2)	1451/1519*
External Load Gross Weight	1519
Useful Load (Gross Wt.-Standard Config. Wt.) [Normal/Optional] (*Note 2)	674/742*
Maximum External Load (Cargo Hook Limit)	680

Note 1: Includes 5.4 kilograms of engine oil. **Ballast** is not included in standard configuration weight (ballast is a function of installed equipment).

PERFORMANCE SUMMARY: (International Standard Day Except as Noted)

••• REFER TO DEMONSTRATED TAKEOFF & LANDING AND MAXIMUM OPERATING ALTITUDE NOTES ON THE PERFORMANCE CHARTS •••

<u>TAKEOFF GROSS WEIGHT</u>		<u>KG</u>	<u>1179</u>	<u>1361</u>	<u>1451</u>	<u>1519</u>
IGE Hovering Ceiling	ISA	M	5974	4633	4023	3597*
(0.6 M skid height)	ISA+20C	M	5121	3749	3109	2682*
OGE Hovering Ceiling	ISA	M	4542	3139	1615	(1519Kg@SL)*
	ISA+20C	M	3597	2195	914	(1488Kg@SL)*
Certificated Altitude	ISA	M	6096	6096	4115	4115*
Service Ceiling (MCP)	ISA	M	6096+	5547	4115	4115*
(0.5 M/S)						
Sea Level Max R/C (TOP)	ISA	M/S	9.9	7.7	6.9	6.2*
Maximum Allowable IAS	ISA, SL	km/h	241	241	226	144*
	ISA, 1524M	km/h	230	230	200	144*
MCP True Airspeed	ISA, SL	km/h	224	219	213	143*
@ Takeoff GW	ISA, 1524M	km/h	237	226	213	154*
Range @ LRC Speed	ISA, SL	km	721	708	693	667*
(Avg. GW, Full Fuel)	ISA, 1524M	km	837	800	778	746*
Endurance, @ Loiter 96 km/h	ISA, SL	hr	4.7	4.6	4.5	4.4*
(No Reserve)						

Note 2: Operation at Internal Gross Weight above 1451 Kilograms requires the Optional STC Increased Internal Gross Weight to 1519.5 Kilograms Kit (FMS-37).

ENGINE POWER RATINGS:

(**STANDARD** Rolls-Royce 250-C20J) Uninstalled Mechanical Rating

Takeoff , kW	313
Maximum Continuous, kW	276

TRANSMISSION RATINGS:

Takeoff , kW	236
Maximum Continuous, kW	201

FUEL:

Type	Aviation Turbine
Capacity (Usable)	344 Liters

THE DATA SET FORTH ON THIS DOCUMENT ARE GENERAL IN NATURE AND MAY VARY WITH CONDITIONS. FOR PERFORMANCE DATA AND OPERATING LIMITATIONS FOR ANY SPECIFIC FLIGHT MISSION, REFERENCE MUST BE MADE TO THE APPROVED FLIGHT MANUAL.



JETRANGER III SEATING

CREW SEATING - Two individual ergonomically designed seats with adjustable lumbar support, each equipped with seat belt, double strap shoulder harness and inertia reel, are located in the cockpit. The color and upholstery material for the seats, and interior trim of the cockpit match that which is selected for the cabin.

STANDARD INTERIOR

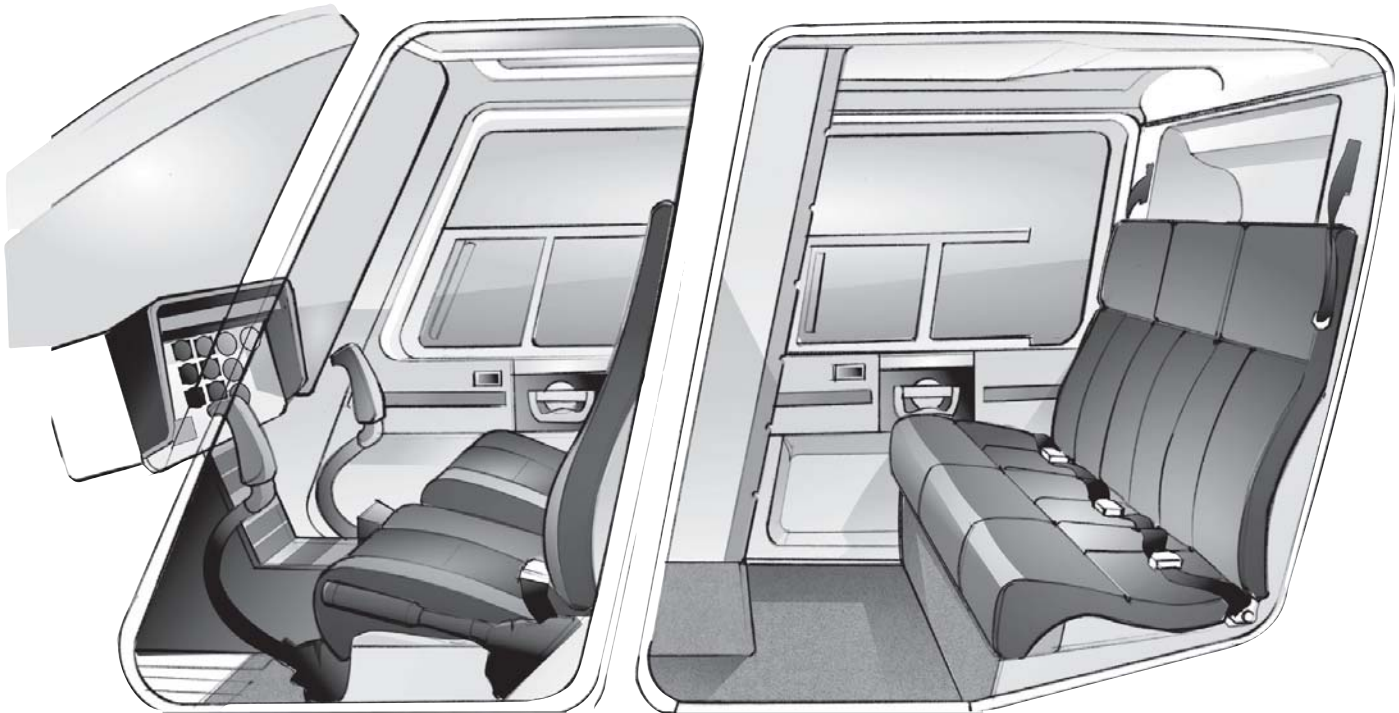

STANDARD SEATING & INTERIOR TRIM - The **standard** cabin seating consists of **three equal width** seats with individual seat belts and single strap shoulder harness, arranged across the rear of the cabin. Available with Red, Blue, Tan, or Gray **fabric** upholstery with Black seat belts. All vinyl upholstery, or vinyl with fabric inserts are available as an **extra cost** option. **The standard interior trim** consists of plastic closeouts on sidewalls/window reveals, hat box, fuel cell and control column. The floor is covered in low loop lightweight blend carpet. The standard seating and interior trim are included in the basic aircraft weight.

Specifications subject to change without notice.



CORPORATE INTERIOR

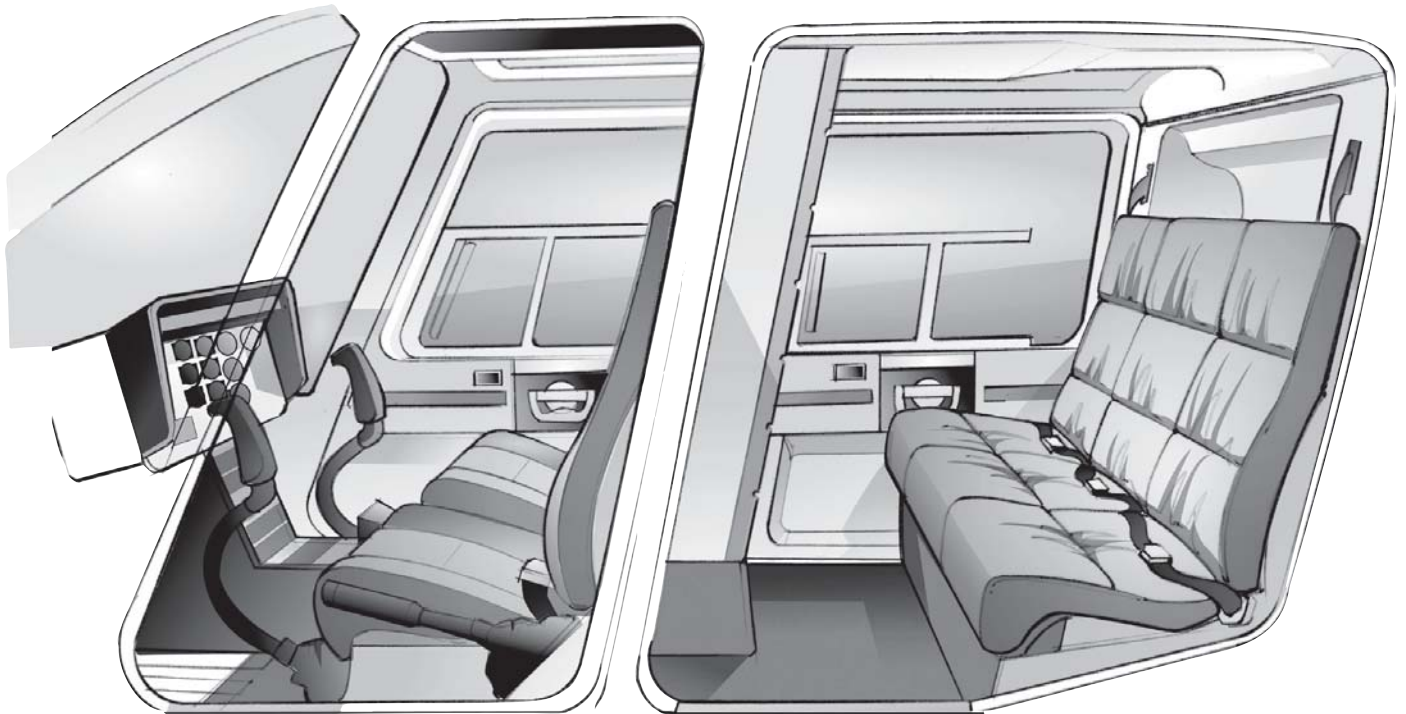

*CORPORATE SEATING & INTERIOR TRIM - The corporate cabin seating consists of **three equal width** seats with individual seat belts and single strap shoulder harness, arranged across the rear of the cabin. Available with Pewter, Mushroom, Dark Blue, Saddle, Burgundy, Smoke Grey, and Forest Green upholstery with Black seat belts. Seats can be all fabric (basic corporate seats), or optional leather with fabric inserts, or all leather with perforated leather inserts. Carpet is 100% wool cut pile.*

Specifications subject to change without notice.



STANDARD CONFIGURATION
(Items Included In List Price)**AIRFRAME**

Cabin; bonded aluminum honeycomb, and semi-monocoque structure
Engine mount struts with noise dampers
Doors, four, hinged forward, dual point latching
Landing gear, tubular skid type with replaceable skid shoes
Locks for cabin doors and luggage compartment
Luggage compartment (16 ft³ [.45 M³], 250 lbs [113 Kg]cap), with Composite Door
Provisions for mooring, jacking and single point lifting
Tail boom, monocoque structure with vertical fin and fixed elevator
Tail skid (tail rotor guard)
Windshield (and Chin Windows), clear plexiglass
Windows, blue tinted plexiglass with sliding panels in doors, Passenger Cabin "Wedge" Windows
Three color exterior paint scheme
Rain gutters

INTERIOR

Standard 5-place interior with soundproofing, carpeting, & data case.
Color options available for upholstery & carpet
5-place shoulder harnesses, dual straps in cockpit, single strap in cabin
Fire extinguisher, cabin
First aid kit
Parcel shelf (behind aft seat)
Ram air ventilation system

POWERPLANT

Rolls-Royce Model **250-C20J** gas turboshaft engine
Wet spline starter-generator
Fuel boost pumps (2 canister type) submerged in fuel tanks
Fuel control, Bendix
Fuel filter (eliminates PRIST requirements)
Fuel system, 91 gal. (344 liter) capacity

Oil system, 1.5 gal [5.7 liter] capacity
Compressor wash provisions

ROTORS & CONTROLS

Main rotor, semi-rigid, two-bladed, see-saw type with precone and underslung feathering axis. All metal blades that are moisture proofed and epoxy encapsulated.
Flap restraints.
CHOICE of *STANDARD* [black top-white bottom] or *HIGH VISIBILITY* [orange/white top-white bottom] painted rotor blades
Tail rotor; semi-rigid, two-bladed, see-saw type
Hydraulic boost system (pump and reservoir module)
Mechanical flight control linkages throughout

TRANSMISSION DRIVE SYSTEM

Focused pylon mounting
Freewheeling unit (between engine and main transmission)
Gearbox, tail rotor with 2.3:1 spiral bevel gear reduction
Hydraulic pump (for boost controls)
Main transmission 2 stage 15.22:1 planetary reduction
Oil cooler
Oil filter with replaceable type cartridge
Oil pump, constant pressure

FLIGHT & ENGINE INSTRUMENTS

Clock, digital quartz chronometer
Compass, magnetic
Dual tachometer (rotor and engine)
Inclinometer
Indicator, airspeed
Indicator, altimeter
Indicator, engine oil pressure/temperature
Indicator, free air temperature
Indicator, fuel quantity
Indicator, fuel pressure/generator load
Indicator, gas producer speed
Indicator, torque/pressure

Specifications subject to change without notice.



STANDARD CONFIGURATION (continued)
(Items Included In List Price)**FLIGHT & ENGINE INSTRUMENTS (cont.)**

Indicator, transmission oil pressure/
temperature
Indicator, turbine outlet temperature
with over temp light
Hour meter

MONITORING SYSTEM

Caution indication lights
Baggage door open
Engine fuel pump inoperative
Engine failure warning
Fuel filter by-pass indicator
Generator failure
Transmission oil pressure
Transmission oil temperature
Chip detectors, magnetic--engine,
main transmission, tail rotor gearbox
Engine out and low rotor RPM warning
lights and horn with mute switch
Battery temperature sensor
Battery hot
Freewheeling unit/magnetic plug
Fuel Low Warning

ELECTRICAL

28 volt DC system
Battery, 17 amp-hr nickel-cadmium
External power and grounding
receptacles
Lights:
Anti-collision strobe
Cockpit/map
Instrument
Landing (two 250 watt)
Position
Starter-generator (150 ampere)
Voltage regulator, Solid State
28 volt outlet in cabin
Heated pitot tube

MISCELLANEOUS

Covers, turbine inlet and exhaust pipes
Cover pitot tube
Flight bag
Grounding handling wheels w/lift tube
Operating manuals;
Aircraft log book
Engine log book
Engine operating manual
Engine parts manual
Flight manual
Illustrated parts catalog
Maintenance & overhaul manual
Tie-down assemblies, main rotor and
tail rotor

Specifications subject to change without notice.



OPTIONAL ACCESSORIES

• • • • • REFER TO NOTES FOR KIT COMPATIBILITY • • • • •

Part Number	Kit Description	Wt (lbs)	Wt (Kg)	Notes
AIRFRAME				
206-706-031-109	HIGH SKID GEAR (INCL. AAI FLIGHT STEPS)	32.2	14.6	(1, 13)
206-706-127-111	DUAL CONTROLS	9.6	4.4	
206-706-211-109	LIGHT WEIGHT POP-OUT FLOATS	148.0	67.1	(1)
206-706-510-101	SKID GEAR FAIRINGS	10.3	4.7	(2)
AVIONICS				
206-705-008-103	VHF EQUIPMENT (KX-155)	7.7	3.5	
206-705-008-115	TRANSPONDER PROVISIONS (KT-76A)	1.0	0.5	(3)
206-705-008-117	TRANSPONDER EQUIPMENT (KT-76A)	2.5	1.1	(3)
206-705-008-131	ADF EQUIPMENT (KR-87)	7.1	3.2	
206-705-008-151	OMNI W/ PROVISIONS (KI208)	3.4	1.5	
206-705-008-155	TRANSPONDER PROVISIONS (DIGITAL) (KT-70)	1.0	0.5	(3)
206-705-008-157	TRANSPONDER EQUIPMENT (DIGITAL) (KT-70)	3.9	1.8	(3)
206-705-008-167	VHF/ADF PROVISIONS W/ AUDIO PANEL (KMA24H-71)	10.6	4.8	
206-706-007-101	ENCODING ALTIMETER	0.9	0.4	(1, 3)
206-706-051-101	BLIND ENCODING ALTIMETER	2.0	0.9	(3)
206-706-323-111	FLIGHT INSTRUMENTS [for less Dir. Gyro. See Note/Credits]	10.5	4.8	(4)
ENGINE				
206-706-038-105	AUTO RE-LIGHT FOR C-20J ENGINE	0.4	0.2	
206-706-038-107	AUTO RE-LIGHT (STC SH4781NM) FOR C-20R ENGINE	2.4	1.1	
206-706-200-111	PARTICLE SEPARATOR	7.3	3.3	(1)
ENVIRONMENT				
206-705-400-101	STANDARD HEADLINER w/ A/C DUCTS [for STC A/C]	11.0	5.0	(5)
EQUIPMENT				
206-706-034-107	ROTOR BRAKE	11.6	5.3	
206-706-126-105	RESCUE HOIST	35.1	15.9	
206-706-126-109	RESCUE HOIST PROVISIONS	11.8	5.4	
206-706-136-101	SNOW BAFFLE	0.8	0.4	(12)
206-706-214-103	HOIST CABLE GUARD	2.1	1.0	
206-706-314-103	LITTER PROVISIONS [Dual Litter System]	16.9	7.7	
206-706-324-103	LITTER EQUIPMENT [Two folding litters]	33.0	15.0	
206-706-330-101	AUXILIARY 13 AMP HOUR BATTERY (AFT)	6.0	2.7	(6)
206-706-335-101	CARGO HOOK EQUIPMENT	22.7	10.3	
206-706-335-107	CARGO HOOK PROVISIONS	4.1	1.9	
INTERIOR				
206-705-717-103	CORPORATE SEATS	0.0	0.0	(1, 11)
206-706-039-105	SOUND PROOFING	20.6	9.3	

Specifications subject to change without notice.



OPTIONAL ACCESSORIES (continued)

***** REFER TO NOTES FOR KIT COMPATIBILITY *****

Part Number	Kit Description	Wt (lbs)	Wt (Kg)	Notes
PAINT				
HIGH VISIBILITY	MARKINGS FOR HIGH VIS. M/R BLADES (WHITE & ORANGE)	0.0	0.0	(7)
STC's				
ENVIRONMENT				
206-0102-1	AIR CONDITIONER EQUIPMENT [Air Com]	113.0	51.3	(5)
EQUIPMENT				
SX-16C/016551	NIGHTSUN SEARCHLIGHT	69.6	31.6	(8)
965-36502-002	WIRE STRIKE - RECOMMENDED KIT - SEE NOTE			(9)
	LOW SKIDS	16.4	7.4	
	HIGH SKIDS	17.4	7.9	
PRODUCTION OPTION [NOT A KIT]				
680-1000-5	C20/R4 ENGINE OPTION	26.0	11.8	(10)
Credits				
AVIONICS				
206-075-606-107	DIRECTIONAL GYRO	-3.6	-1.6	(4)
EQUIPMENT				
206-050-127-009/010	GROUND HANDLING WHEELS	27.0	12.2	
PAINT				
NO EXTERIOR	NO EXTERIOR PAINT	-14.8	-6.7	
WHITE	WHITE PAINT ONLY	0.0	0.0	

All equipment kits require Provision Kits prior to installation

Notes: For commonality, notes shown below are identical in Product Specification and Price List.

- 1) Price and/or weight includes credit for basic ship hardware.
- 2) Only compatible with low skid gear.
- 3) Encoding Altimeter or Blind Encoder required to enable Mode C or Mode S Altitude reporting. Customer is responsible for obtaining Aircraft ID code for Mode S.
- 4) Flight Instruments Less D. G. requires a Sales Order Amendment (Kit number is the SAME).
- 5) The Standard Headliner with A/C Ducts is required for installation of the STC Air Com airconditioner.
- 6) Provisions Only - The 13 amp hour battery weighs an additional 24.5 lbs (11.1 kg).
- 7) Standard or High Visibility Main Rotor Blade Paint to be specified by Sales Order.
- 8) Requires High Skids.
- 9) The Wire Strike Kit is a RECOMMENDED extra cost option. The customer must specify on the Purchase Agreement for the WSPS Kit NOT to be installed.
- 10) Includes STC Kit 174104-01 (Facet External Engine Oil Filter) 4.0 lbs (1.8 kg.).
- 11) Material type to be called out on Sales Order. Can be Leather, Fabric/Leather, or Fabric.
- 12) Particle Separator and Auto Relight Kits are required for installation of Snow Baffles.
- 13) "J Steps" (4 each) may be substituted for the AAI FlightSteps by Sales Order. Substitution of "J Steps" reduce High Skid Kit installed weight by 10.5 lbs (4.8 kg.).

STC Kits - Select Supplemental Type Certificated Optional Equipment Kits are available for installation at the Bell Helicopter Textron factory. Please contact your Bell Sales Representative for availability and pricing information.

P.O.R. - Priced On Request.

Specifications subject to change without notice.



INTENTIONALLY LEFT BLANK



HELICOPTER PERFORMANCE
IGE & OGE HOVER, SERVICE CEILING
FOR
STANDARD ROLLS-ROYCE 250-C20J ENGINE
&
OPTIONAL ROLLS-ROYCE 250-C20R/4
ENGINE
BASIC INLET INSTALLED
MINIMUM SPEC. ENGINE



STANDARD, ROLLS-ROYCE 250-C20 B/J ENGINE, BASIC INLET HOVERING CEILING IGE

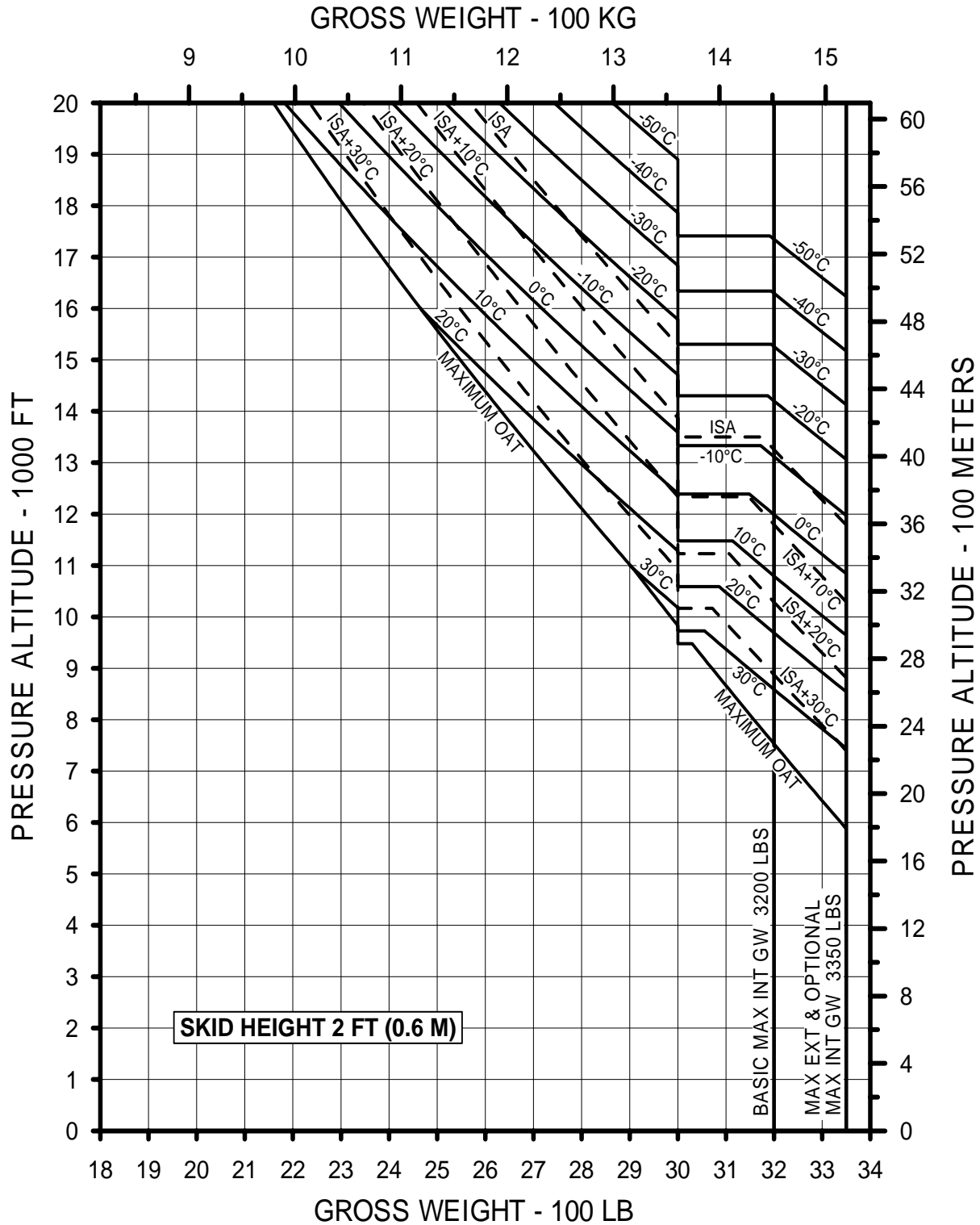

NOTE: TAKEOFF AND LANDING HAS NOT BEEN DEMONSTRATED AND IS NOT APPROVED ABOVE 16,000 FEET / 4877 METERS **DENSITY ALTITUDE**.

THE DATA SET FORTH ON THIS DOCUMENT ARE GENERAL IN NATURE AND MAY VARY WITH CONDITIONS. FOR PERFORMANCE DATA AND OPERATING LIMITATIONS FOR



STANDARD, ROLLS-ROYCE 250-C20 B/J ENGINE, BASIC INLET HOVERING CEILING OGE

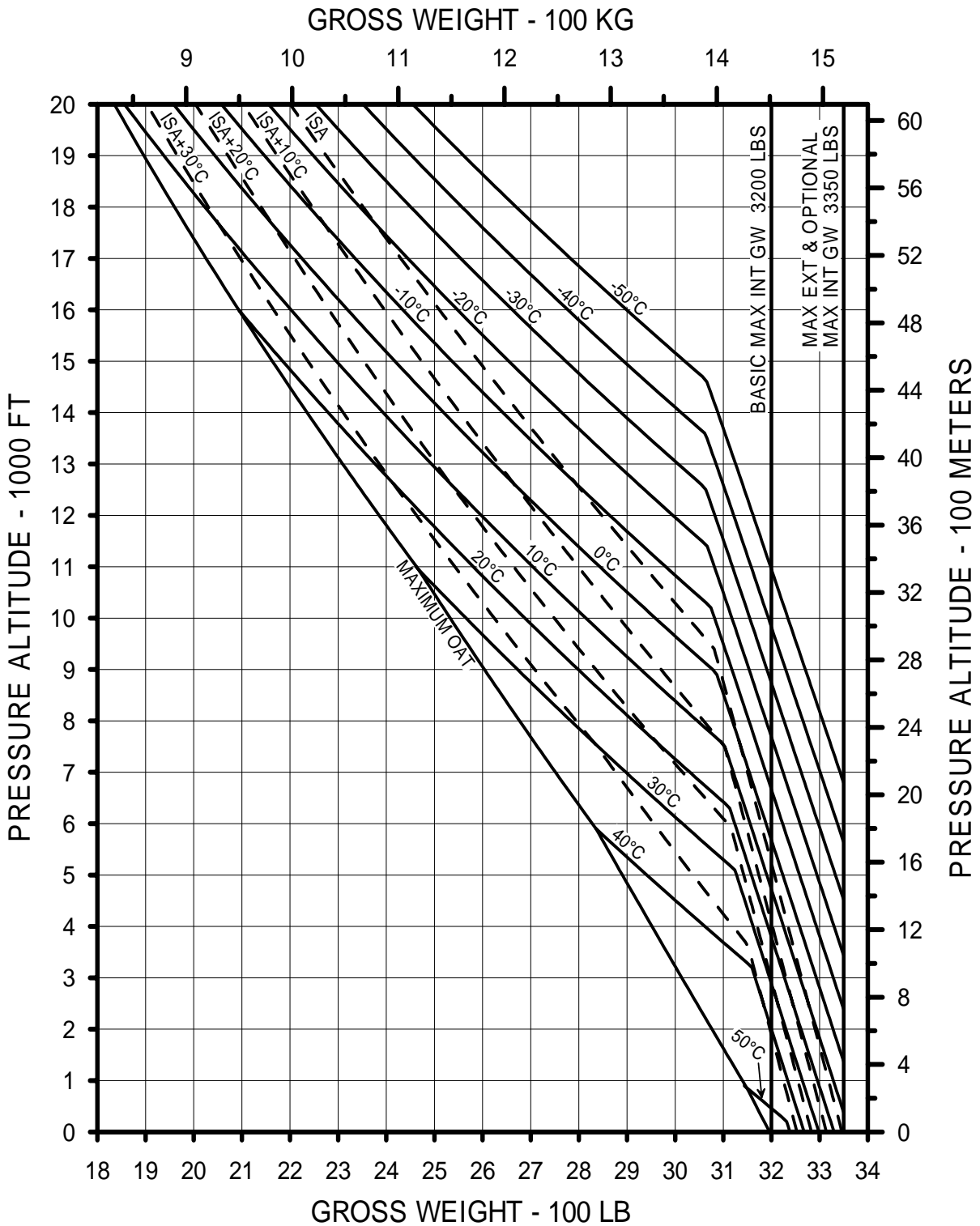

NOTE: TAKEOFF AND LANDING HAS NOT BEEN DEMONSTRATED AND IS NOT APPROVED ABOVE 16,000 FEET / 4877 METERS **DENSITY ALTITUDE**.

THE DATA SET FORTH ON THIS DOCUMENT ARE GENERAL IN NATURE AND MAY VARY WITH CONDITIONS. FOR PERFORMANCE DATA AND OPERATING LIMITATIONS FOR



OPTIONAL, ROLLS-ROYCE 250-C20 R/4 ENGINE, BASIC INLET HOVERING CEILING IGE

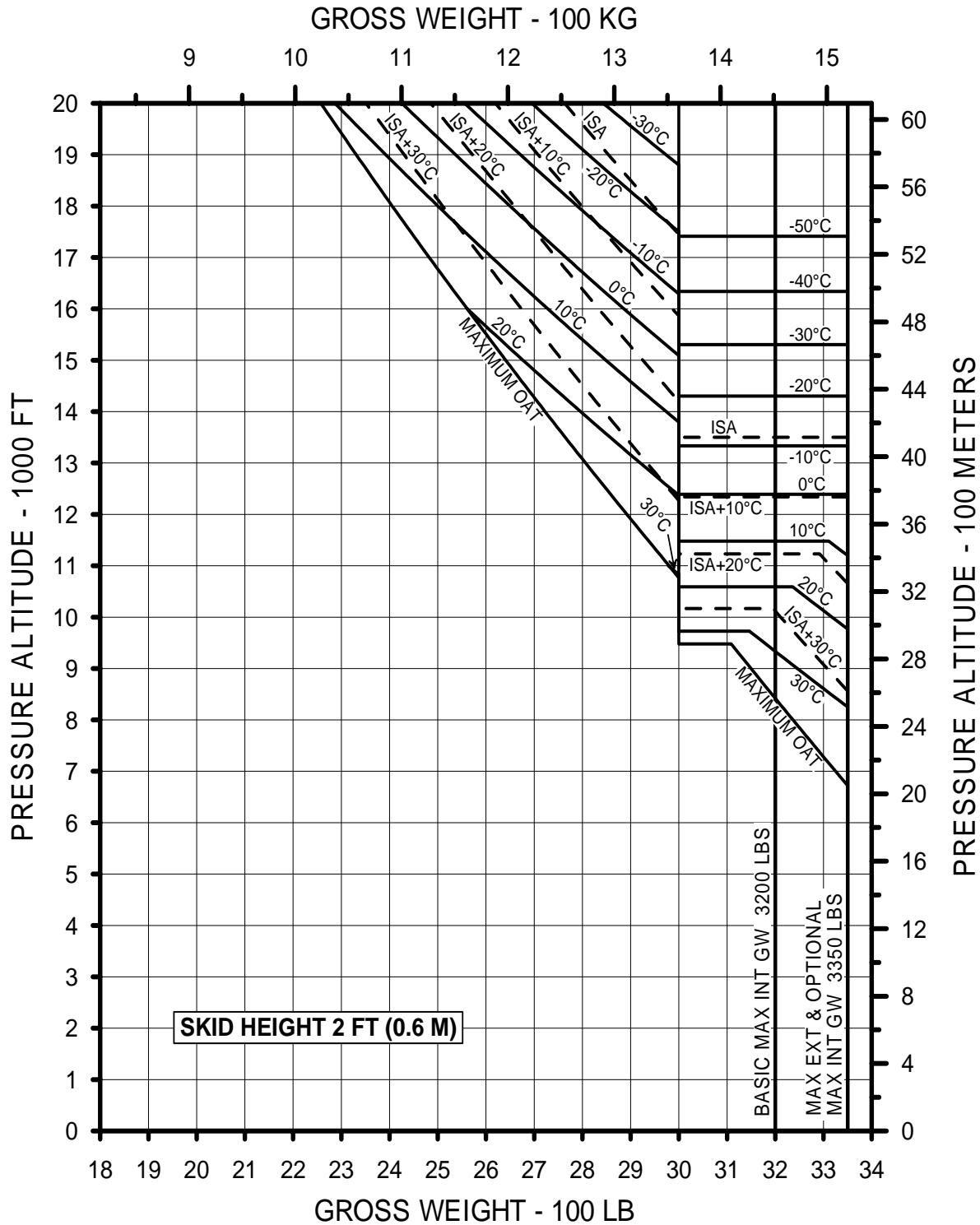

NOTE: TAKEOFF AND LANDING HAS NOT BEEN DEMONSTRATED AND IS NOT APPROVED ABOVE 16,000 FEET / 4877 METERS **DENSITY ALTITUDE**.

THE DATA SET FORTH ON THIS DOCUMENT ARE GENERAL IN NATURE AND MAY VARY WITH CONDITIONS. FOR PERFORMANCE DATA AND OPERATING LIMITATIONS FOR



OPTIONAL, ROLLS-ROYCE 250-C20 R/4 ENGINE, BASIC INLET HOVERING CEILING OGE

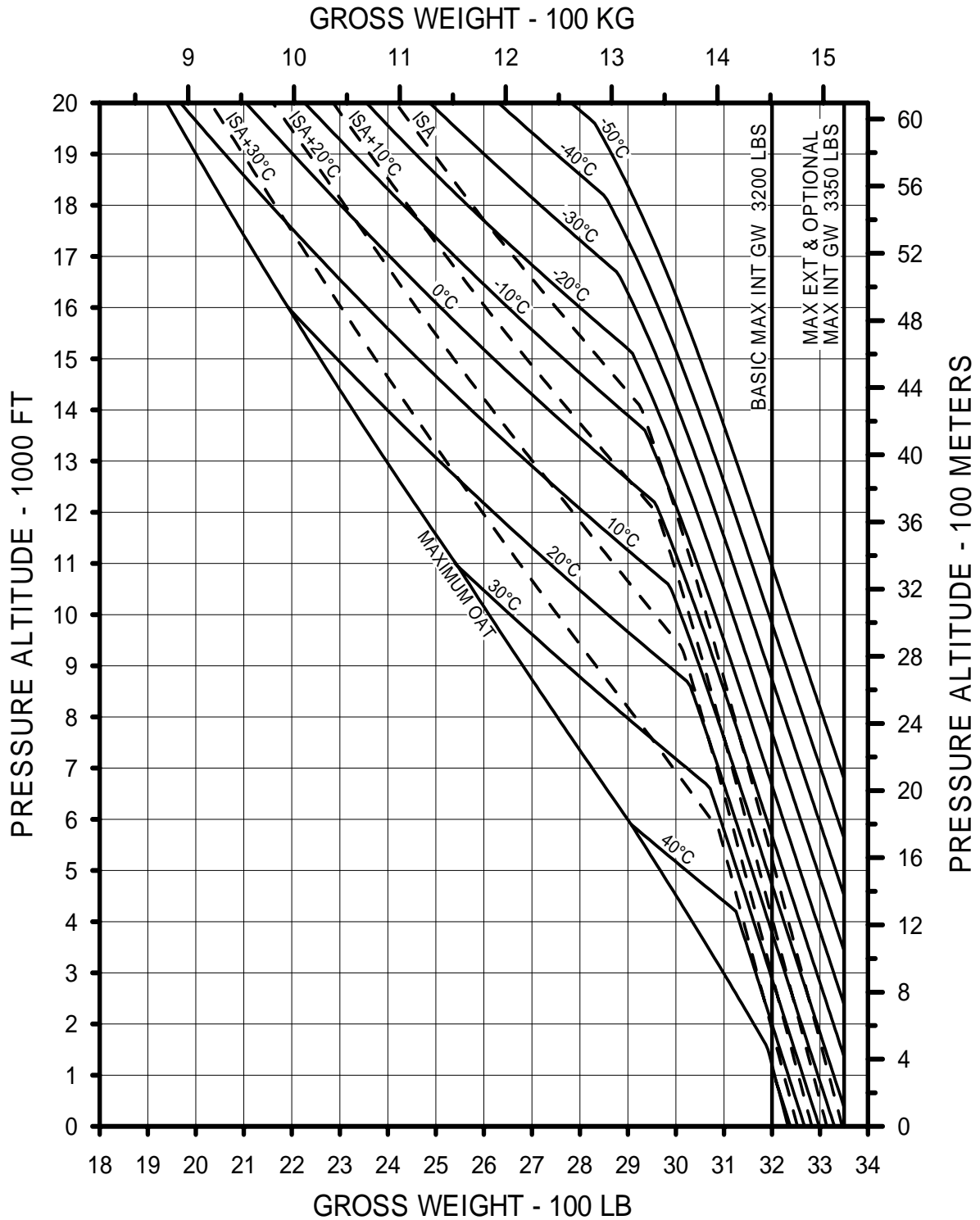

NOTE: TAKEOFF AND LANDING HAS NOT BEEN DEMONSTRATED AND IS NOT APPROVED ABOVE 16,000 FEET / 4877 METERS **DENSITY ALTITUDE**.

THE DATA SET FORTH ON THIS DOCUMENT ARE GENERAL IN NATURE AND MAY VARY WITH CONDITIONS. FOR PERFORMANCE DATA AND OPERATING LIMITATIONS FOR



SERVICE CEILING

**STANDARD, ROLLS-ROYCE 250-C20 B/J ENGINE, BASIC INLET AT MCP
100 FPM (0.5 M/S) RATE OF CLIMB**

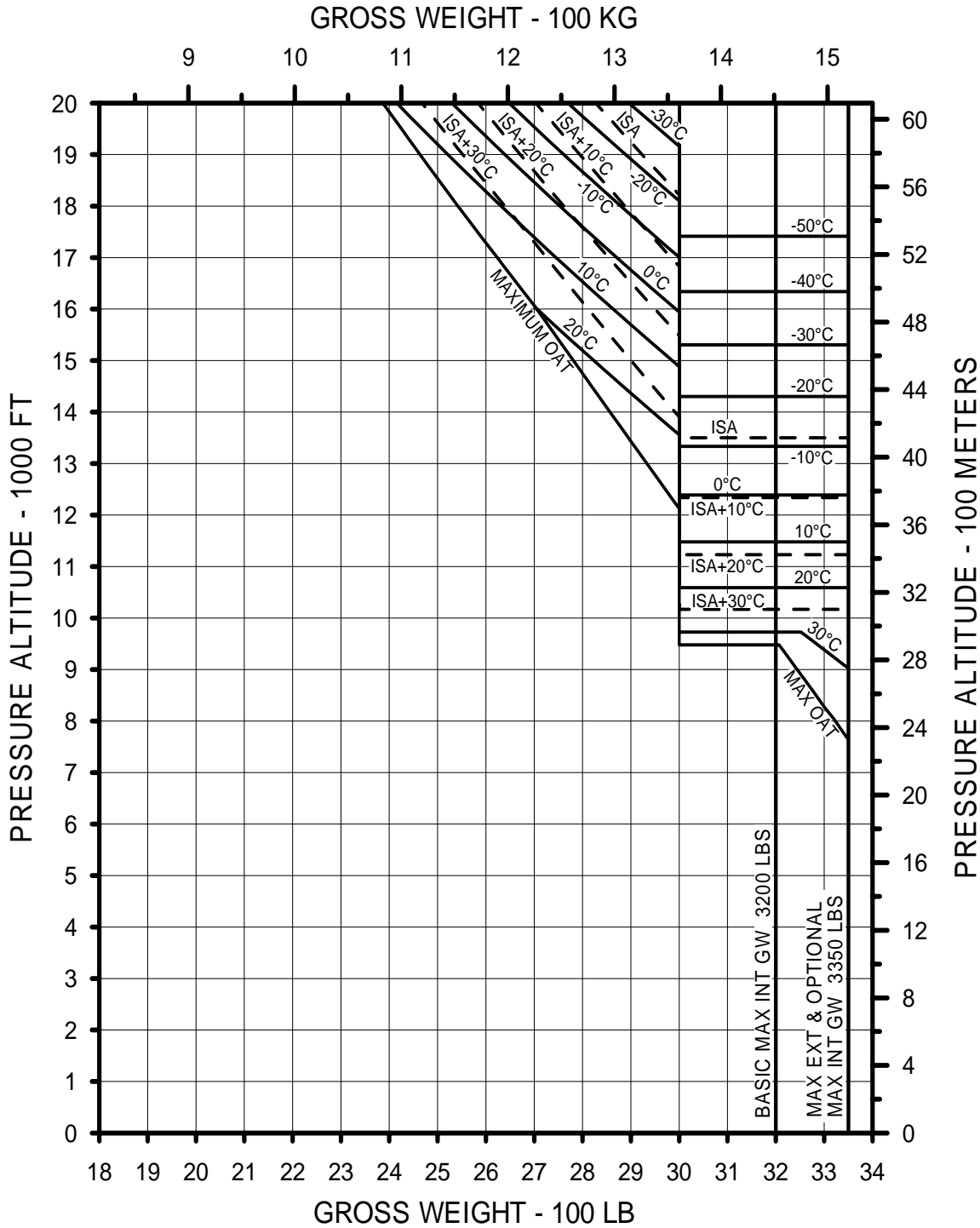

NOTE: MAXIMUM OPERATING ALTITUDE FOR ALL GROSS WEIGHTS ABOVE 3000 POUNDS/1361 KILOGRAMS IS 13,500 FEET / 4115 METERS DENSITY ALTITUDE.

THE DATA SET FORTH ON THIS DOCUMENT ARE GENERAL IN NATURE AND MAY VARY WITH CONDITIONS. FOR PERFORMANCE DATA AND OPERATING LIMITATIONS FOR ANY SPECIFIC FLIGHT MISSION, REFERENCE MUST BE MADE TO THE APPROVED FLIGHT MANUAL.



SERVICE CEILING OPTIONAL, ROLLS-ROYCE 250-C20 R ENGINE, BASIC INLET AT MCP 100 FPM (0.5 M/S) RATE OF CLIMB

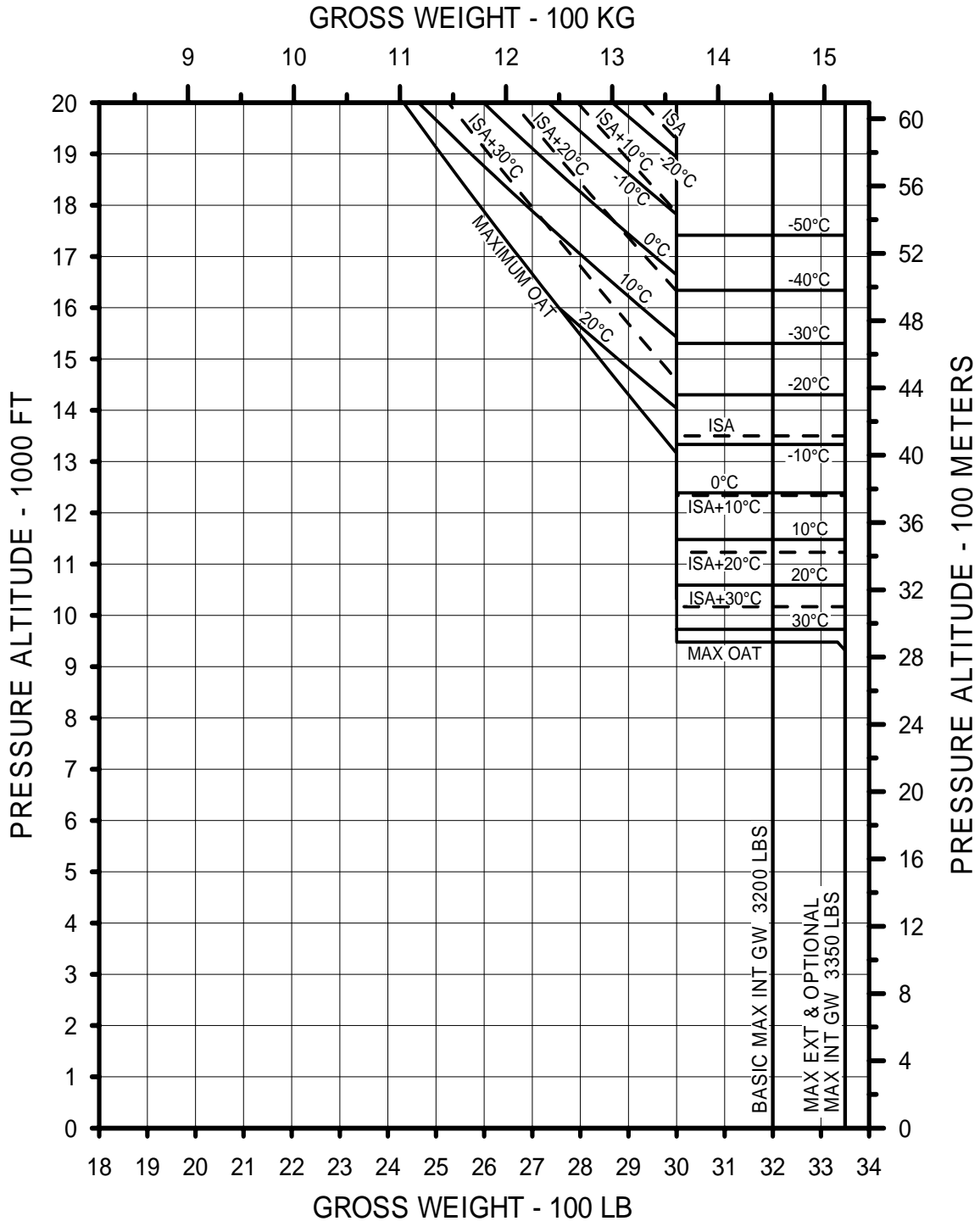

NOTE: MAXIMUM OPERATING ALTITUDE FOR ALL GROSS WEIGHTS ABOVE 3000 POUNDS/1361 KILOGRAMS IS 13,500 FEET / 4115 METERS **DENSITY ALTITUDE**.

THE DATA SET FORTH ON THIS DOCUMENT ARE GENERAL IN NATURE AND MAY VARY WITH CONDITIONS. FOR PERFORMANCE DATA AND OPERATING LIMITATIONS FOR ANY SPECIFIC FLIGHT MISSION, REFERENCE MUST BE MADE TO THE APPROVED FLIGHT MANUAL.



INTENTIONALLY LEFT BLANK



FUEL FLOW vs AIRSPEED
ISA & ISA+20° C
ROLLS-ROYCE 250-C20B/J ENGINE
BASIC INLET INSTALLED
LOW SKID GEAR WITHOUT FAIRINGS
with PLUS ENGINE DATA*

**FOR PARTICLE SEPARATOR INSTALLED;
INCREASE FUEL FLOW TWO(2)LB/HR[ONE(1)KG/HR]
FOR CROSS TUBE FAIRINGS;
INCREASE AIRSPEED TWO(2)KNOTS[FOUR(4)KM/HR]**

NOTES:

THE BEST ALLOWABLE CRUISE SPEED IS EITHER LONG RANGE CRUISE SPEED [LRC], OR WHEN SPEED IS LIMITED BY MAXIMUM CONTINUOUS CRUISE POWER [MCP] OR V_{NE} THE MAXIMUM SPEED PERMITTED .

*** PLUS ENGINE DATA IS SHOWN WHERE THERE IS A SIGNIFICANT DIFFERENCE BETWEEN MINIMUM SPECIFICATION ENGINE POWER (A "ZERO" ENGINE) AND EITHER MAXIMUM CONTINUOUS POWER OR THE ENGINE MECHANICAL POWER LIMIT. THIS DATA IS PROVIDED TO ASSIST PLANNING OF OPERATIONS WHERE FAST CRUISE SPEED IS DESIRED, BUT THE CONTINUOUS OPERATION LIMITS OF 85% TORQUE AND / OR 738 °C ENGINE TOT ARE OBSERVED. THE MAXIMUM ATTAINABLE FAST CRUISE SPEED WILL BE DETERMINED BY SPECIFIC ENGINE HEALTH (POWER ASSURANCE), AND OPERATIONAL LIMIT (TORQUE, TOT, N1, OR V_{NE} , WHICHEVER OCCURS FIRST).**

PLUS ENGINE PERCENT CAN BE DETERMINED DURING THE ENGINE POWER ASSURANCE CHECK BY SETTING THE TOT AND RECORDING TORQUE. THE DIFFERENCE BETWEEN THE RECORDED TORQUE AND THE MINIMUM CHART VALUE IS THE PLUS PERCENT FACTOR.



FUEL FLOW
ROLLS-ROYCE 250-C20B/J ENGINE
PRESSURE ALTITUDE = SEA LEVEL
OAT = +15° C

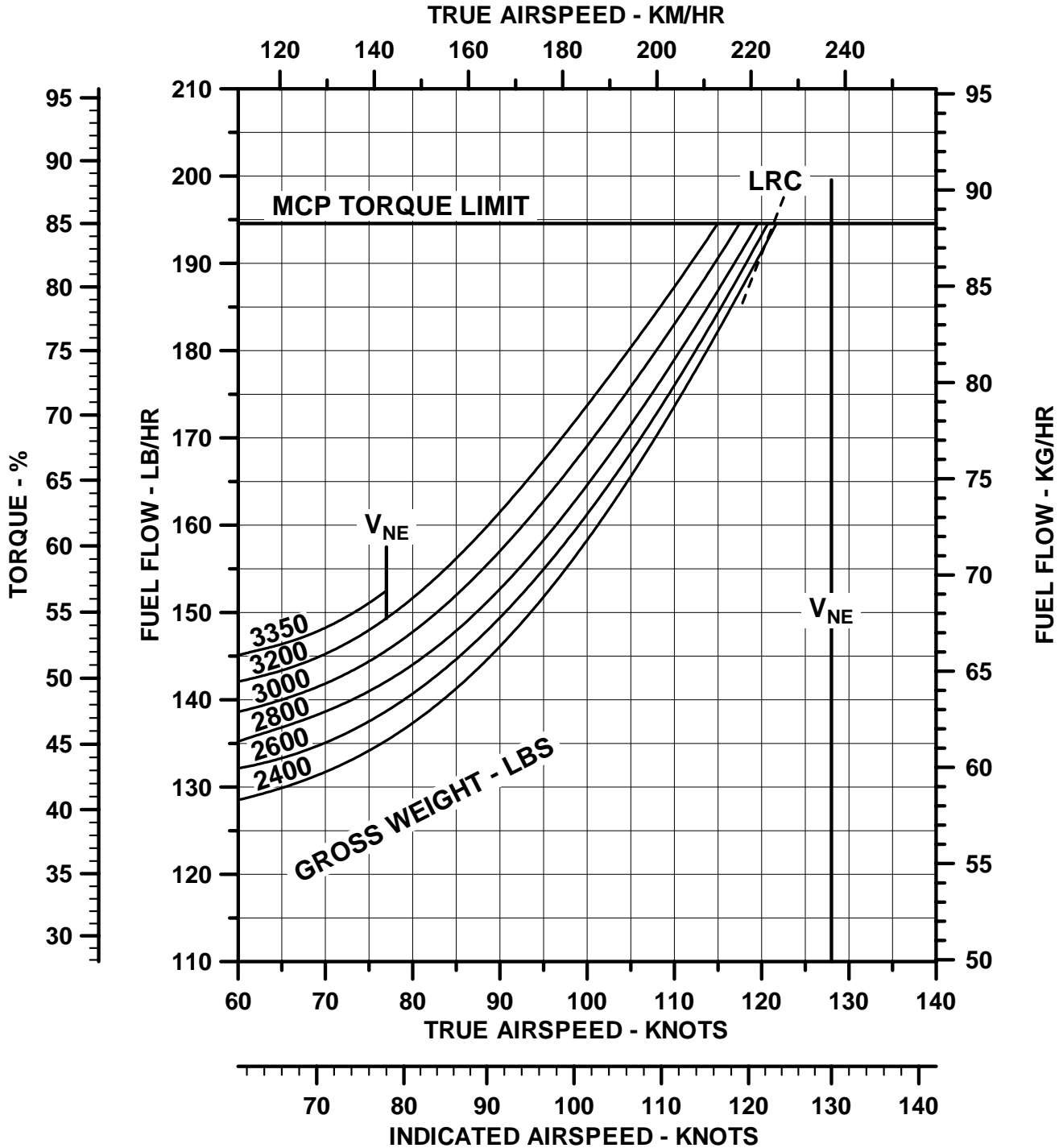

THE DATA SET FORTH ON THIS DOCUMENT ARE GENERAL IN NATURE AND MAY VARY WITH CONDITIONS. FOR PERFORMANCE DATA AND OPERATING LIMITATIONS FOR ANY SPECIFIC FLIGHT MISSION, REFERENCE MUST BE MADE TO THE APPROVED FLIGHT MANUAL.



FUEL FLOW
ROLLS-ROYCE 250-C20B/J ENGINE
PRESSURE ALTITUDE = 2000 FEET
OAT = +11°C

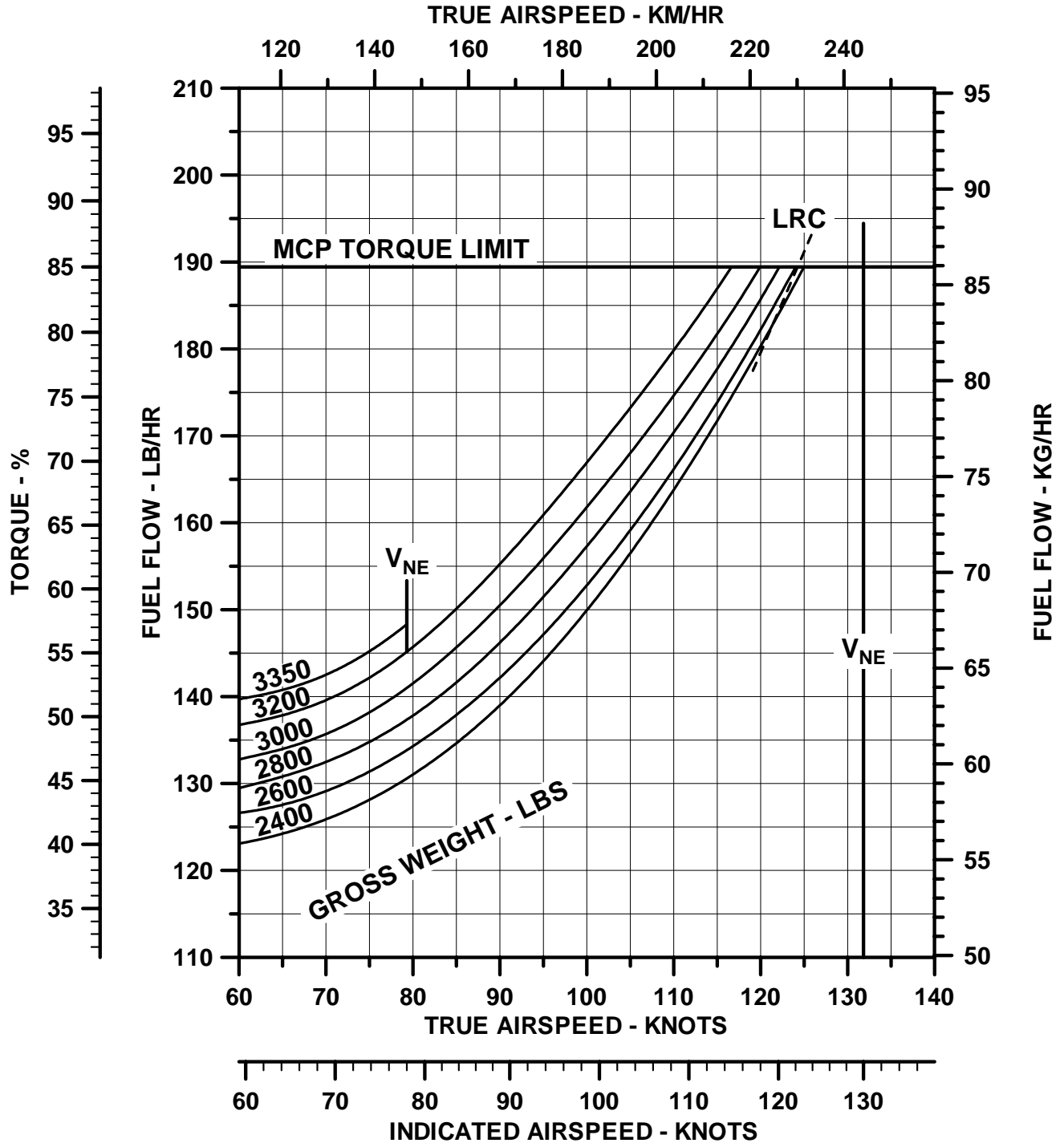

THE DATA SET FORTH ON THIS DOCUMENT ARE GENERAL IN NATURE AND MAY VARY WITH CONDITIONS. FOR PERFORMANCE DATA AND OPERATING LIMITATIONS FOR ANY SPECIFIC FLIGHT MISSION, REFERENCE MUST BE MADE TO THE APPROVED FLIGHT MANUAL.



FUEL FLOW
ROLLS-ROYCE 250-C20B/J ENGINE
PRESSURE ALTITUDE = 4000 FEET
OAT = +7° C

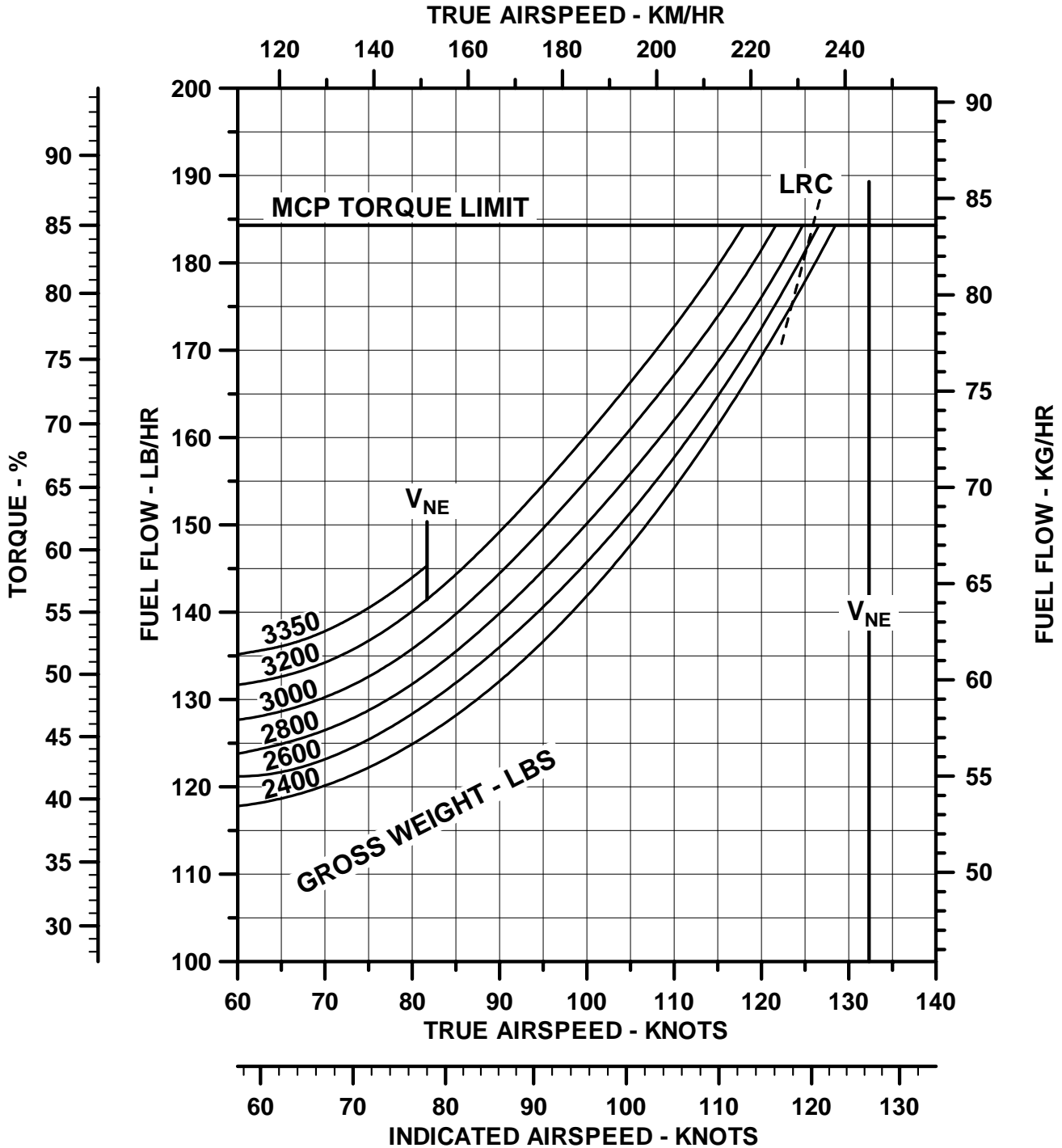

THE DATA SET FORTH ON THIS DOCUMENT ARE GENERAL IN NATURE AND MAY VARY WITH CONDITIONS. FOR PERFORMANCE DATA AND OPERATING LIMITATIONS FOR ANY SPECIFIC FLIGHT MISSION, REFERENCE MUST BE MADE TO THE APPROVED FLIGHT MANUAL.



FUEL FLOW
ROLLS-ROYCE 250-C20B/J ENGINE
PRESSURE ALTITUDE = 6000 FEET
OAT = +3°C

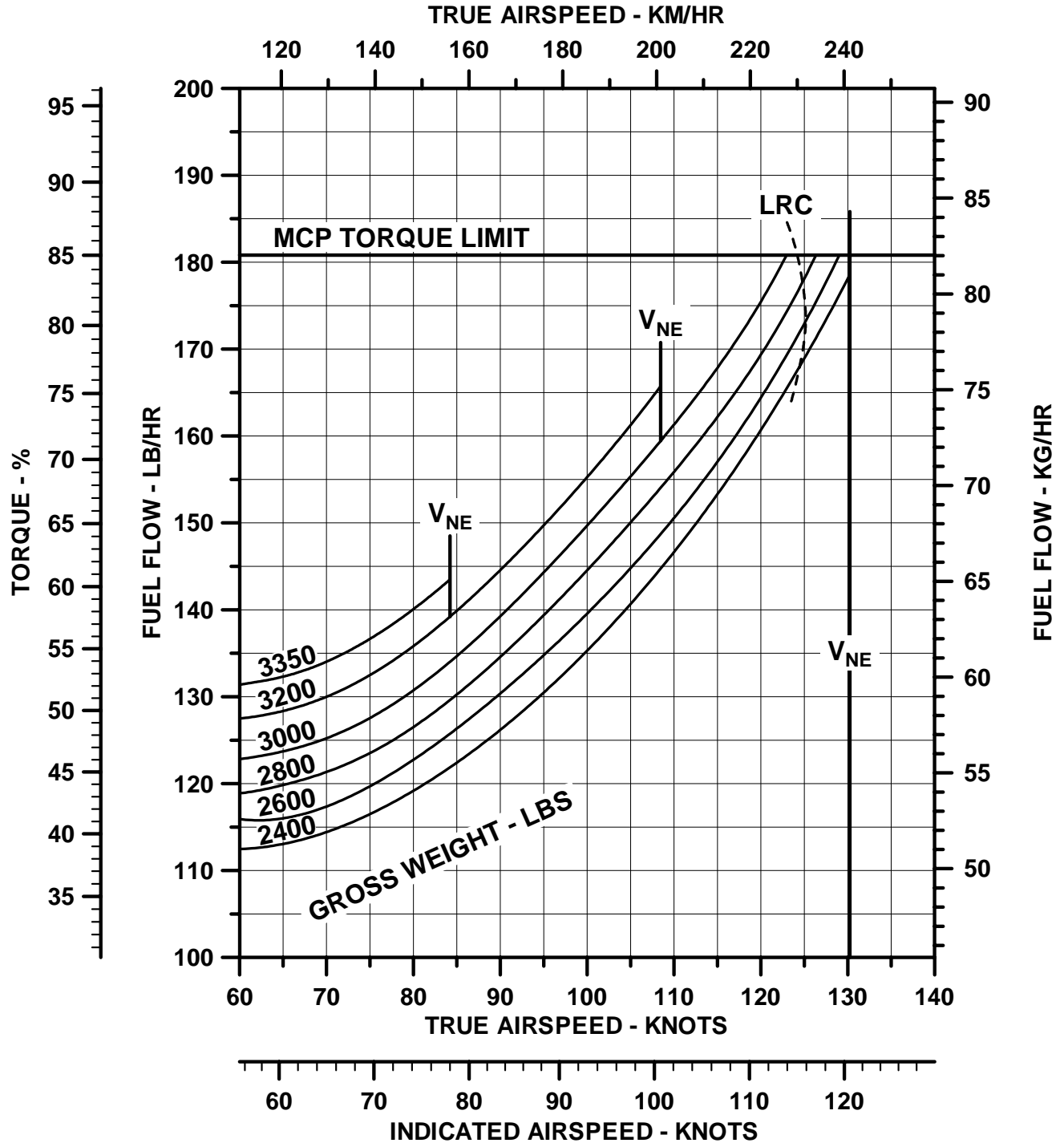

THE DATA SET FORTH ON THIS DOCUMENT ARE GENERAL IN NATURE AND MAY VARY WITH CONDITIONS. FOR PERFORMANCE DATA AND OPERATING LIMITATIONS FOR ANY SPECIFIC FLIGHT MISSION, REFERENCE MUST BE MADE TO THE APPROVED FLIGHT MANUAL.



FUEL FLOW
ROLLS-ROYCE 250-C20B/J ENGINE
PRESSURE ALTITUDE = 8000 FEET
OAT = -1°C

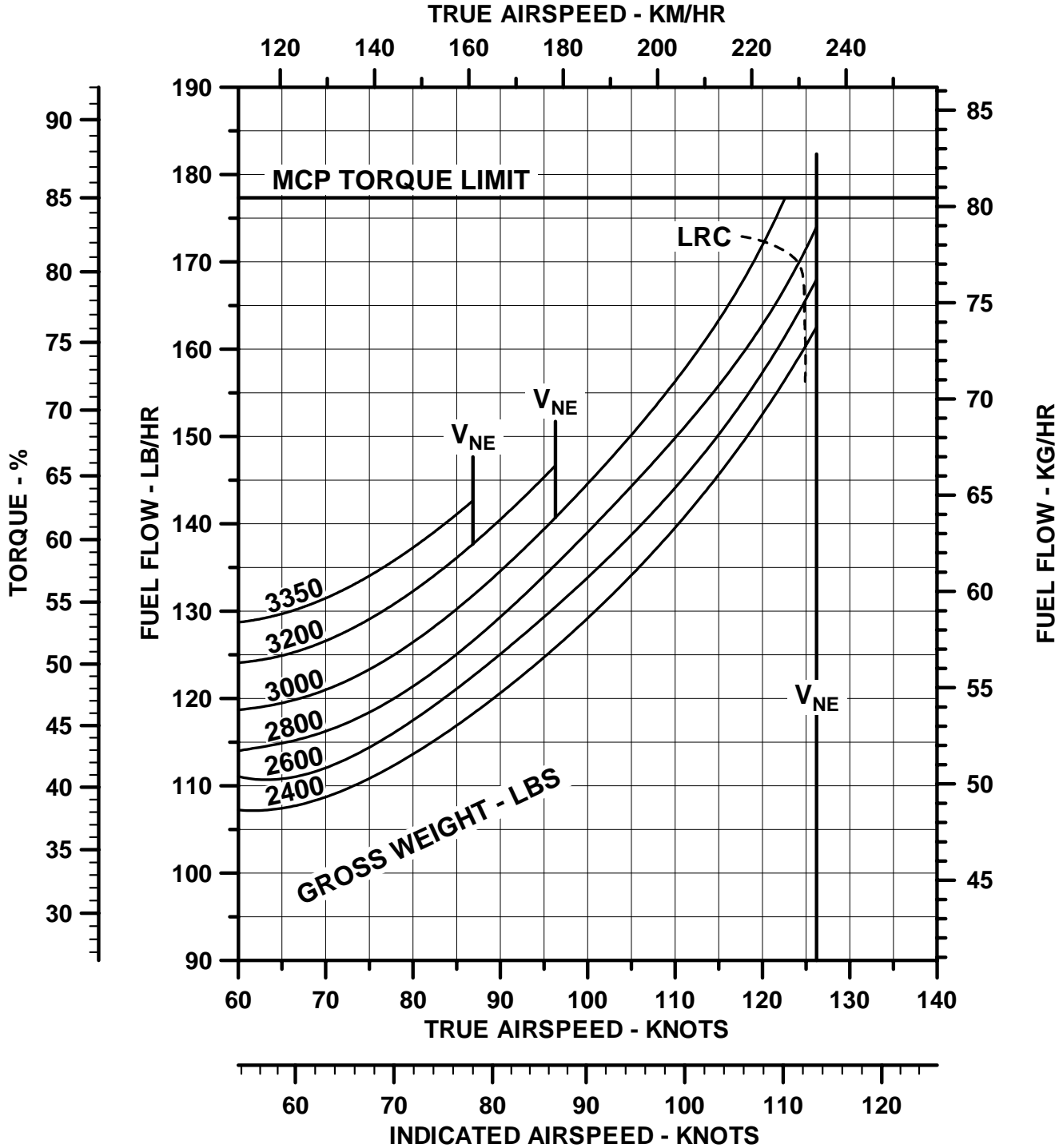

THE DATA SET FORTH ON THIS DOCUMENT ARE GENERAL IN NATURE AND MAY VARY WITH CONDITIONS. FOR PERFORMANCE DATA AND OPERATING LIMITATIONS FOR ANY SPECIFIC FLIGHT MISSION, REFERENCE MUST BE MADE TO THE APPROVED FLIGHT MANUAL.



FUEL FLOW
ROLLS-ROYCE 250-C20B/J ENGINE
PRESSURE ALTITUDE = SEA LEVEL
OAT = +35° C

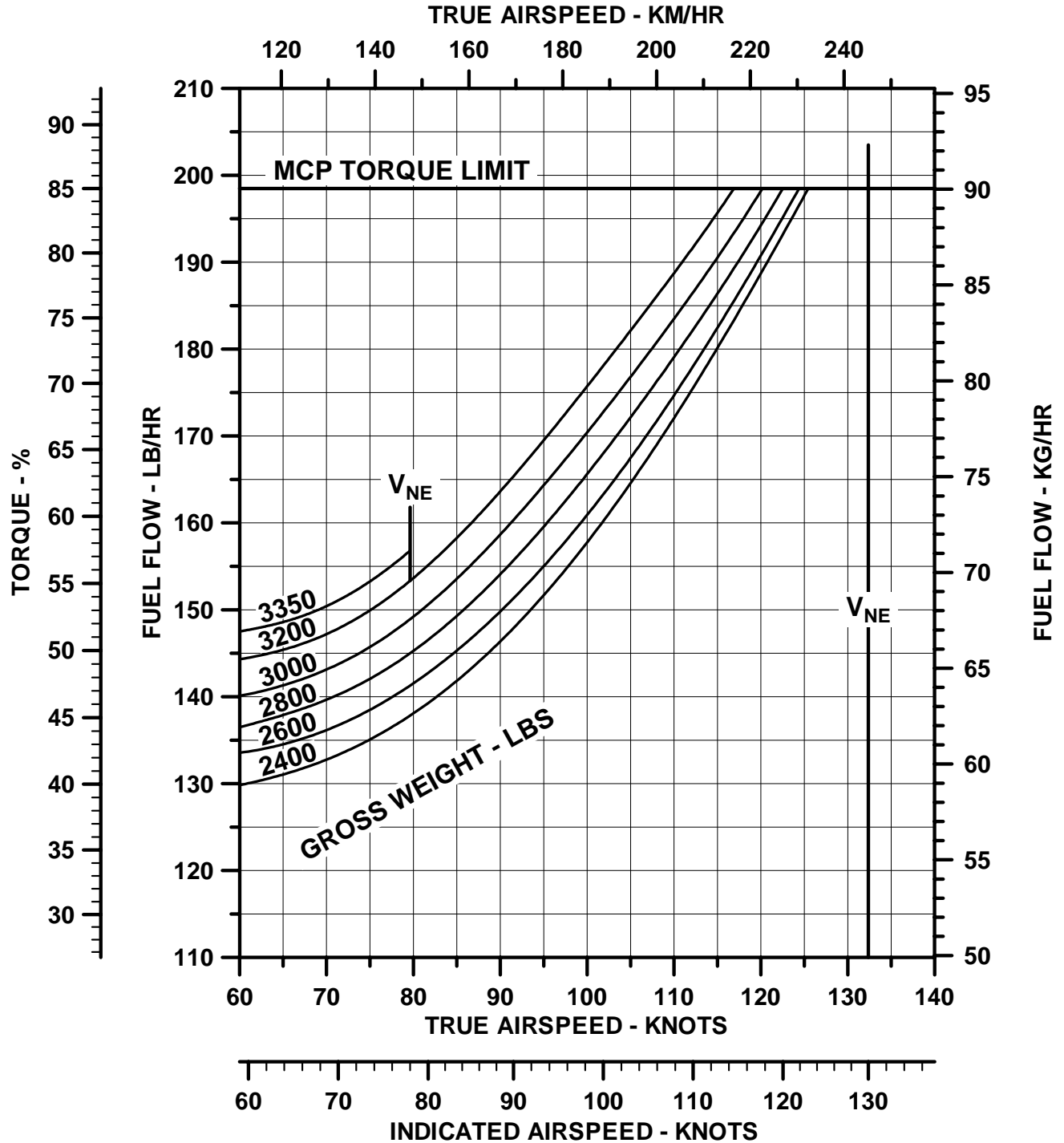

THE DATA SET FORTH ON THIS DOCUMENT ARE GENERAL IN NATURE AND MAY VARY WITH CONDITIONS. FOR PERFORMANCE DATA AND OPERATING LIMITATIONS FOR ANY SPECIFIC FLIGHT MISSION, REFERENCE MUST BE MADE TO THE APPROVED FLIGHT MANUAL.



FUEL FLOW
ROLLS-ROYCE 250-C20B/J ENGINE
PRESSURE ALTITUDE = 2000 FEET
OAT = +31°C

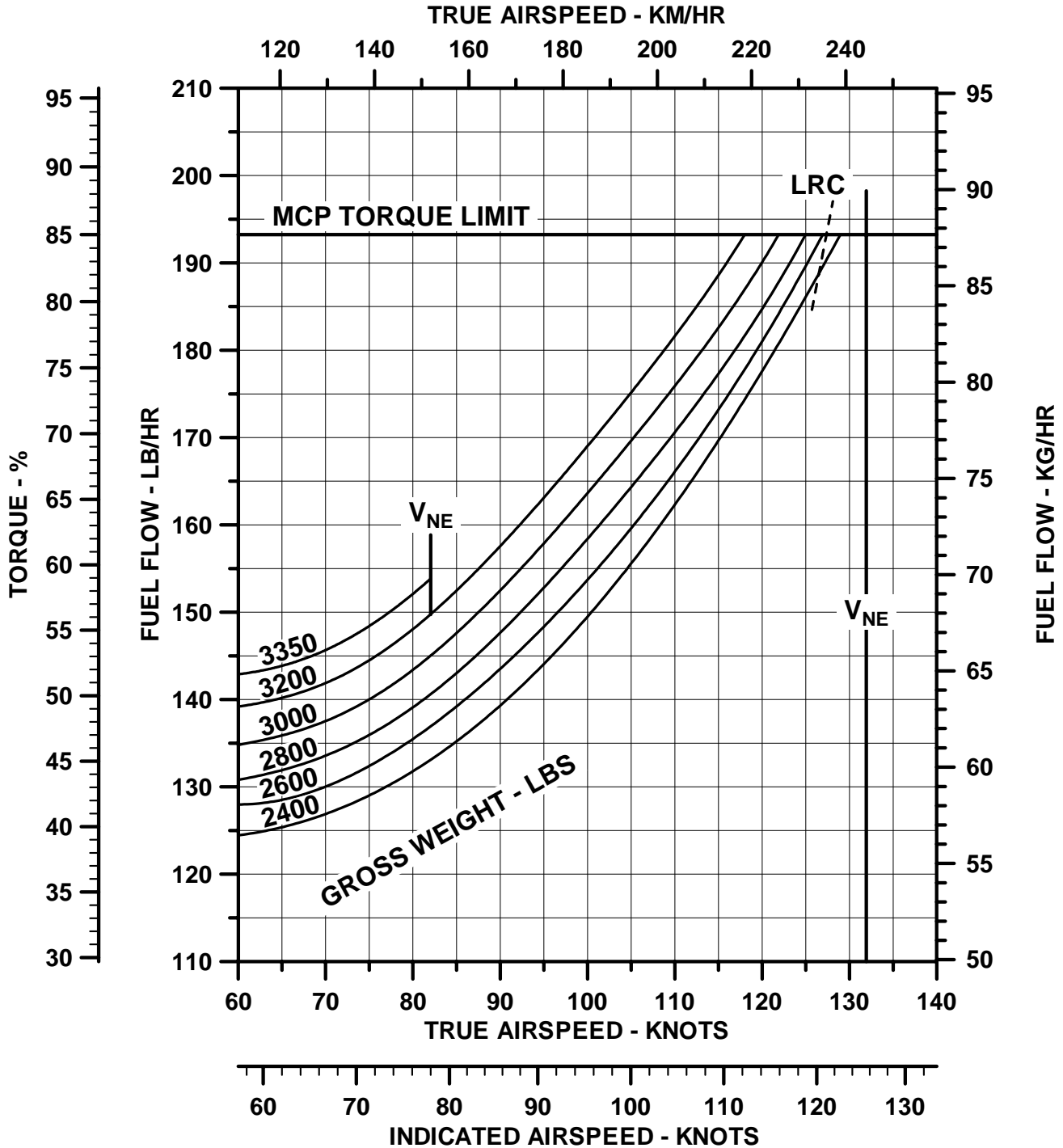

THE DATA SET FORTH ON THIS DOCUMENT ARE GENERAL IN NATURE AND MAY VARY WITH CONDITIONS. FOR PERFORMANCE DATA AND OPERATING LIMITATIONS FOR ANY SPECIFIC FLIGHT MISSION, REFERENCE MUST BE MADE TO THE APPROVED FLIGHT MANUAL.



FUEL FLOW
 ROLLS-ROYCE 250-C20B/J ENGINE
 PRESSURE ALTITUDE = 4000 FEET
 OAT = +27° C

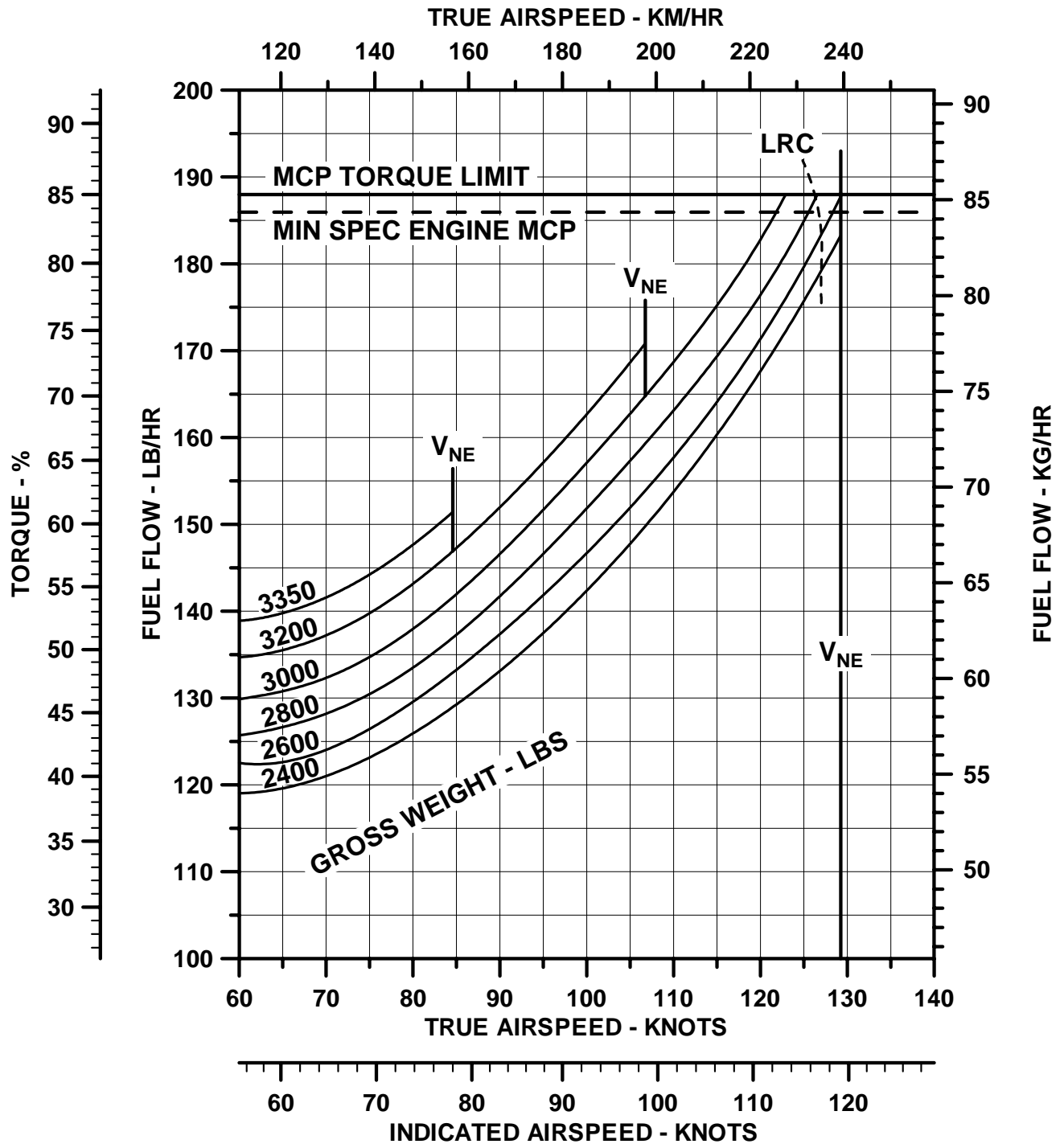

THE DATA SET FORTH ON THIS DOCUMENT ARE GENERAL IN NATURE AND MAY VARY WITH CONDITIONS. FOR PERFORMANCE DATA AND OPERATING LIMITATIONS FOR ANY SPECIFIC FLIGHT MISSION, REFERENCE MUST BE MADE TO THE APPROVED FLIGHT MANUAL.



FUEL FLOW
ROLLS-ROYCE 250-C20B/J ENGINE
PRESSURE ALTITUDE = 6000 FEET
OAT = +23° C

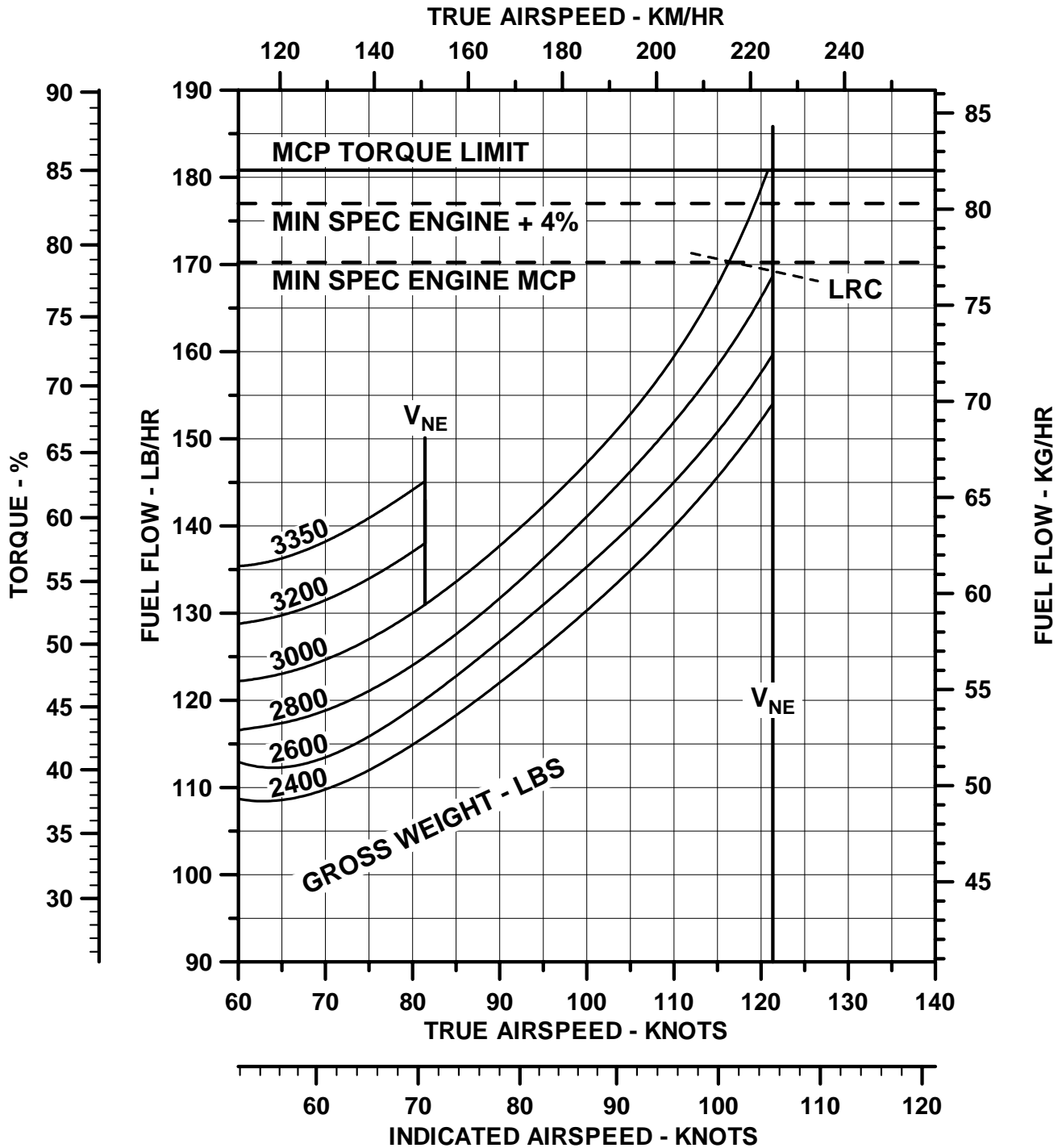

THE DATA SET FORTH ON THIS DOCUMENT ARE GENERAL IN NATURE AND MAY VARY WITH CONDITIONS. FOR PERFORMANCE DATA AND OPERATING LIMITATIONS FOR ANY SPECIFIC FLIGHT MISSION, REFERENCE MUST BE MADE TO THE APPROVED FLIGHT MANUAL.



FUEL FLOW
ROLLS-ROYCE 250-C20B/J ENGINE
PRESSURE ALTITUDE = 8000 FEET
OAT = +19° C

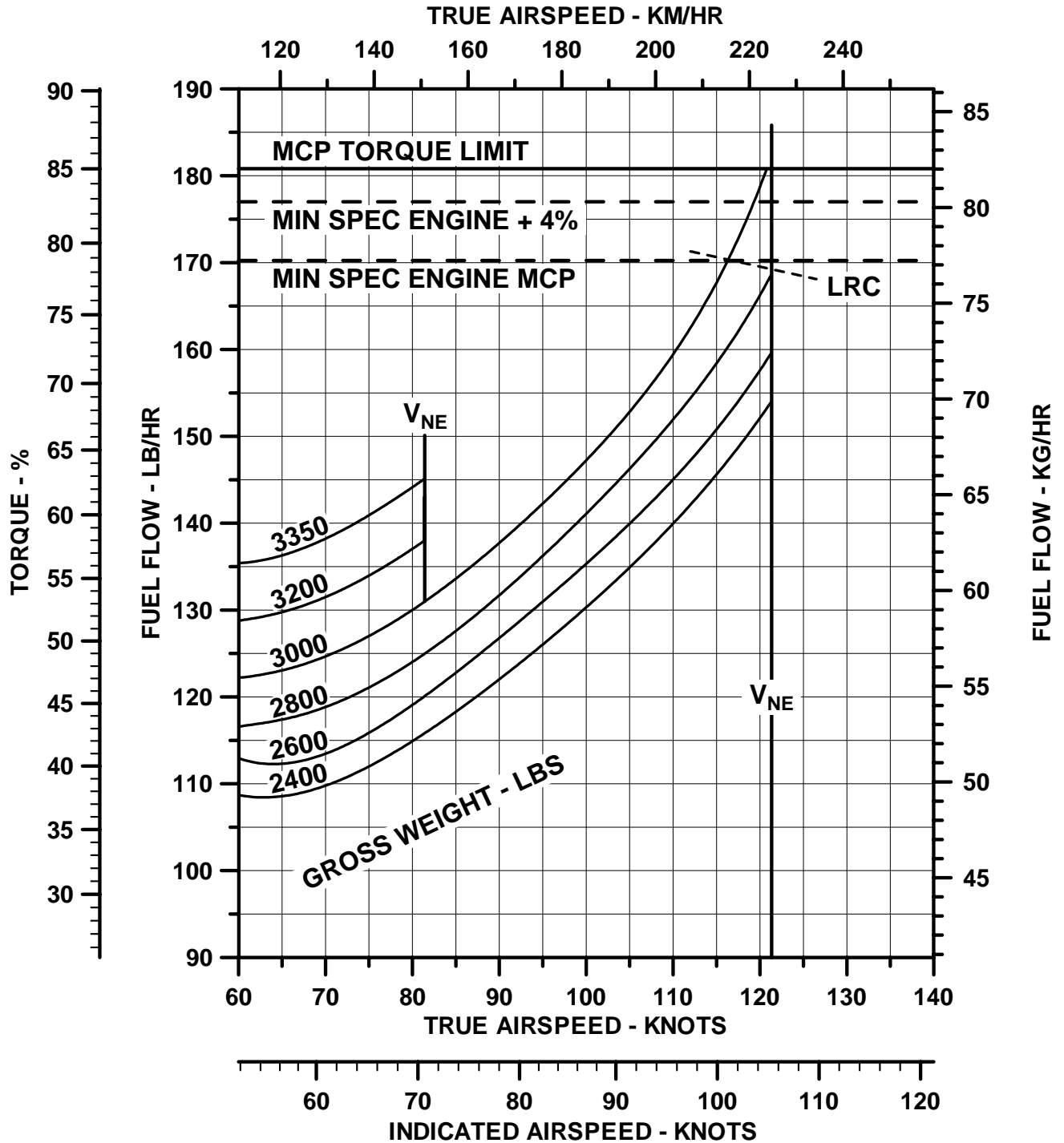

THE DATA SET FORTH ON THIS DOCUMENT ARE GENERAL IN NATURE AND MAY VARY WITH CONDITIONS. FOR PERFORMANCE DATA AND OPERATING LIMITATIONS FOR ANY SPECIFIC FLIGHT MISSION, REFERENCE MUST BE MADE TO THE APPROVED FLIGHT MANUAL.



COST OF OPERATIONS

INTRODUCTION

Bell Helicopter Textron's cost of operations data for current production helicopters is based on information from Bell operators and service facilities.

BHT's Product Support organization accumulates cost data from a diverse group of operators - large, small; sub-polar, subtropical; inland, coastal; corporate, charter. This information is analyzed to generate sample data for each production model which are averages of the field experience.

BHT intends to continue monitoring actual costs to enable annual updates of the data to maintain its currency.

The following discussion is provided to review the variables involved in the helicopter's direct and indirect cost of operations as well as its cost of ownership.

The total cost of helicopter ownership and operation involves both direct and indirect costs. The direct costs are those which are incurred essentially by the flight hour and include:

- Fuel, Lubricants
- Basic Airframe Maintenance
- Powerplant Maintenance

The indirect costs are not directly dependent upon the number of hours flown and include:

- Insurance
- Facilities (hangar, workshop, etc.)
- Crew Compensation
- Financial Factors (depreciation, investment tax credit, financing costs, etc.)

Sample direct operating cost data is available for each current production model. Detailed estimates for total costs relating to specific operations are available through the BHT regional marketing manager or corporate office using input data supplied by customer/prospect.

DIRECT COSTS

Fuel, Lubricants

A typical average value of fuel and lubricant costs is included in the sample data provided for each model.

Fuel consumption depends upon speed, temperature, externally-mounted accessories, sling loads, etc. A band of approximately 10% more or less than sample value will cover these factors for normal operations.

Fuel pricing varies considerably based on where the fuel is purchased geographically and whether it is purchased retail or in bulk. The sample cases use average retail purchase price prevalent at the time of the sample data are prepared.

Basic Airframe Maintenance

Airframe maintenance is divided into four categories:

- Periodic Inspections
- Overhauls
- Replacement of Retirement Parts
- Unscheduled

Periodic inspections include those inspection tasks, with their part requirements, listed in the Maintenance Manual for each model.

Man hours for periodic inspections can vary from the sample value provided because of differences in personal experience, tool and parts availability, facilities, environmental effects such as extremes in working temperatures. Man hour costs/hour are also variable among the Authorized Service Centers as a result of differences in local costs, overhead expenses and volume of work. The sample value is an average of costs per hour at Authorized Service Centers at the time of publication.

Overhauls include removal, disassembly, inspection, parts replacement, reassembly and reinstallation of certain components/assemblies at the periods stated in the BHT Maintenance Manual.

Overhaul man hour and parts requirements are subject to considerable variation depending upon the helicopter's operations and environments. The sample data reflect average values.



COST OF OPERATIONS (continued)

Retirement parts are those which are subject to disposal after an operating time stated in the Maintenance Manual. These are normally components of the rotors/control systems which are subject to oscillatory loads and are designed and tested for use over a finite number of flight hours rather than on their condition. The replacement at the required intervals requires some labor which is included in the man hour data in the sample.

Unscheduled maintenance encompasses labor and parts replacement for major maintenance not covered under the formal Maintenance Manual requirements for inspections and overhauls. It also includes those additional maintenance requirements imposed by the manufacturer through issue of Service Bulletins.

The sample data for periodic inspections provide for some minor unscheduled maintenance tasks resulting from the inspection.

Powerplant Maintenance

The powerplant (engine [s]) requires periodic inspection and overhauls. The overhaul periods are based on the number of operating hours or on the number of cycles, whichever is the first limit to be attained. Start cycles are a factor because thermal cycles are important in the design of the turbine engine's rotating components. Overhauls are performed by the engine manufacturer and/or at authorized facilities.

Powerplant overhaul can be performed for the engine as a unit, or in some cases for individual modules. (Modules can be gearbox, compressor, turbine, for example.) Each module can have its own overhaul period. Modular overhaul can be cost-effective for some operations and it use should be evaluated.

Engine or module exchanges can be made in lieu of overhaul. For details, contact the engine manufacturer or his authorized distributors/service centers. The sample costs are based on an average exchange.

The powerplant may also require unscheduled maintenance (unscheduled removals for repair, parts replacement).

INDIRECT COSTS

Insurance

Insurance rates are based on a number of factors including claim experience, type of operations, and crew qualifications. Rates can be obtained from insurance agent/broker.

Facilities

Facilities can include hangar, workshop, parts storage area, tools, ground support equipment and administrative area as appropriate to the specific operation.

Crew Compensation

The number of aircrew personnel depends on the individual operation; i. e., whether the normal crew consists of one or two pilots, hours per day flown, backup requirements for illness, vacation, etc.

Bell regional marketing managers can advise typical local costs for estimation purposes.

Financial Factors

Funding a helicopter purchase can be accomplished in a variety of ways, including cash, short term note, long term note, partnership, etc. For investment accounting, several depreciation methods also exist; straight line, double declining, sum of the years digits, etc. Value of resale is a significant factor.

Miscellaneous Factors

Staff expenses (other than aircrew and direct maintenance personnel), utilities, office expenses, etc.

OWNERSHIP ANALYSIS PROGRAM

Bell Helicopter Textron uses the **Life Cycle Cost 2005** computer program provided by **Conklin & de Decker Associates, Inc.** to determine ownership costs for an operators planned period of utilization for the aircraft. Conklin's Rotorcraft Analysis Office may be contacted at: Phone; (817)277-6403 or Fax; (817)277-6402.

Bell's regional marketing managers or corporate office personnel will be able to assist in preparing an ownership analysis which is customized for our customers specific individual conditions and needs.



SAMPLE - COST OF OPERATIONS
U S DOLLARS PER FLIGHT HOUR

		<u>Operator Overhaul</u>
<u>Fuel and Lubricants</u>		
Fuel: (Note 1) [28 Gal/Hr]		\$63.00
Lubricants: 3% of Fuel Cost		1.89
<u>Airframe Direct Maintenance</u>		
Labor: (Note 2)		
Inspection	(0.310 MH/FH)	20.13
Overhaul	(0.099 MH/FH)	6.42
Unscheduled and on-condition	(0.379 MH/FH)	24.65
Parts:		
Inspections		2.48
Retirement		35.24
Overhaul		17.73
Unscheduled and on-condition		32.30
<u>Powerplant Direct Maintenance</u>		
Overhaul (Including Accessories- Note 3)		51.94
Line Maintenance (labor)	(0.067 MH/FH)	4.33
<u>TOTAL AVERAGE COST / HR</u>		<u>\$260.11</u>

Note 1: Fuel at \$2.25 per gallon. Average fuel consumption for LRC at 1000 feet, ISA,
 (Jet-A at 6.8 Lb/Gal.)

Note 2: Labor rate assumed at \$65.00 per hour.

Note 3: Includes all scheduled and unscheduled maintenance and life limited parts
 replacement assuming normal operating environment.



LIMITED LIFE COMPONENTS

<u>PART NUMBER</u>	<u>COMPONENT</u>	<u>LIFE (FLT HRS)</u>	<u>QTY PER A/C</u>	<u>LIST PRICE EA</u>	<u>TOTAL COST (FLT HR)</u>
MAIN ROTOR HUB AND BLADE					
206-010-200-133	Main Rotor Blade	5,000	2	\$ 31,098	\$ 12.44
206-011-113-103	Main Rotor Trunnion	4,800	1	\$ 2,220	\$ 0.46
206-011-125-105	Main Rotor Strap Pin	2,500	2	\$ 375	\$ 0.30
206-011-132-113A	Main Rotor Grip	4,800	2	\$ 7,397	\$ 3.08
206-011-150-105	Retention Strap Fitting	2,400	2	\$ 1,666	\$ 1.39
206-011-154-107	Tension-Torsion Strap	1,200	2	\$ 3,573	\$ 5.96
206-011-260-103	Retention Strap Bolt	2,500	2	\$ 636	\$ 0.51
MAIN ROTOR CONTROLS					
206-001-194-001	Lower Collective Tube	4,800	1	\$ 687	\$ 0.14
206-001-566-101	Servo Actuator Support	10,000	1	\$ 11,416	\$ 1.14
206-010-407-001	Collective Lever Idler Link	4,800	1	\$ 863	\$ 0.18
206-010-452-113	Swashplate Support	4,800	1	\$ 6,175	\$ 1.29
206-010-454-109	Swashplate Sleeve Assy	4,800	1	\$ 3,316	\$ 0.69
206-010-467-105	Collective Lever	4,800	1	\$ 1,249	\$ 0.26
POWERTRAIN					
CL42250-1	Freewheeling Unit Clutch	3,000	1	\$ 2,138	\$ 0.71
TAIL ROTOR HUB AND BLADE					
206-011-819-109	Tail Rotor Yoke	5,000	1	\$ 4,666	\$ 0.93
206-016-201-131	Tail Rotor Blade	2,500	2	\$ 5,965	\$ 4.77
206-011-803-005	Tail Rotor Trunnion	2400	1	\$ 1,180	\$ 0.49
TAIL ROTOR GEARBOX					
206-040-410-101	Duplex Bearing	3,000	1	\$ 1,480	\$ 0.49
TOTAL					\$ 35.24

COMPONENT OVERHAUL INTERVALS (HOURS)

M/R Hub	2,400	Freewheeling Assy	3,000	T/R Hub	2,500
Mast Assy	3,000	Swashplate & Support	4,800	Hyd Pump/Resv & Servos	3,600
Transmission	4,500	T/R Gearbox	6,000	T/R Drive System	3,000/3 yrs

Prices and hours are subject to change without notice.

THESE DATA ARE PROVIDED FOR ILLUSTRATION PURPOSES. CONSULT MAINTENANCE DOCUMENTS AND BHT SPARE PARTS PRICING FOR CURRENT, OFFICIAL INFORMATION.



PAIN T SELECTION NOTES:

- 1. COLOR RENDERINGS (ORIGINAL) MUST BE PROVIDED FOR ANY DEVIATION TO THE STANDARD SCHEMES (ALL MODELS).**
- 2. CUSTOM PAINT SCHEMES TO CUSTOMER SPECIFICATION ARE AVAILABLE, AND A PRICE QUOTE WILL BE PROVIDED ON REQUEST. PLEASE PROVIDE AS MUCH DETAIL AS POSSIBLE WHEN DESCRIBING SPECIAL INSTRUCTIONS AND CUSTOM PAINT SCHEMES.**
- 3. THE DANGER ARROW IS ALWAYS APPLIED ON THE TAIL BOOM BETWEEN THE HORIZONTAL STABILIZER AND THE TAIL ROTOR, NOT WITHSTANDING ANY OTHER ILLUSTRATIONS.**
- 4. UNLESS CLEARLY SPECIFIED (LOCATION, DIMENSION, COLOR), REGISTRATION MARKINGS WILL BE APPLIED PER FAA REGULATIONS (ALL MODELS).**
- 5. METALLIC PAINT CAN NOT BE APPLIED OVER RADOME AREAS WHEN A RADAR IS INSTALLED.**
- 6. PLACEMENT OF BELL MODEL LOGOS IS EFFECTED BY INDIVIDUAL PAINT SCHEMES, AND WILL BE APPLIED AT THE DISCRETION OF BELL HELICOPTER UNLESS OTHERWISE SPECIFIED BY THE CUSTOMER.**

CUSTOMER _____
 SERIAL NO. _____
 REGISTRATION NO. _____

Bell 206B3

Standard Scheme A #206B-5/99-A

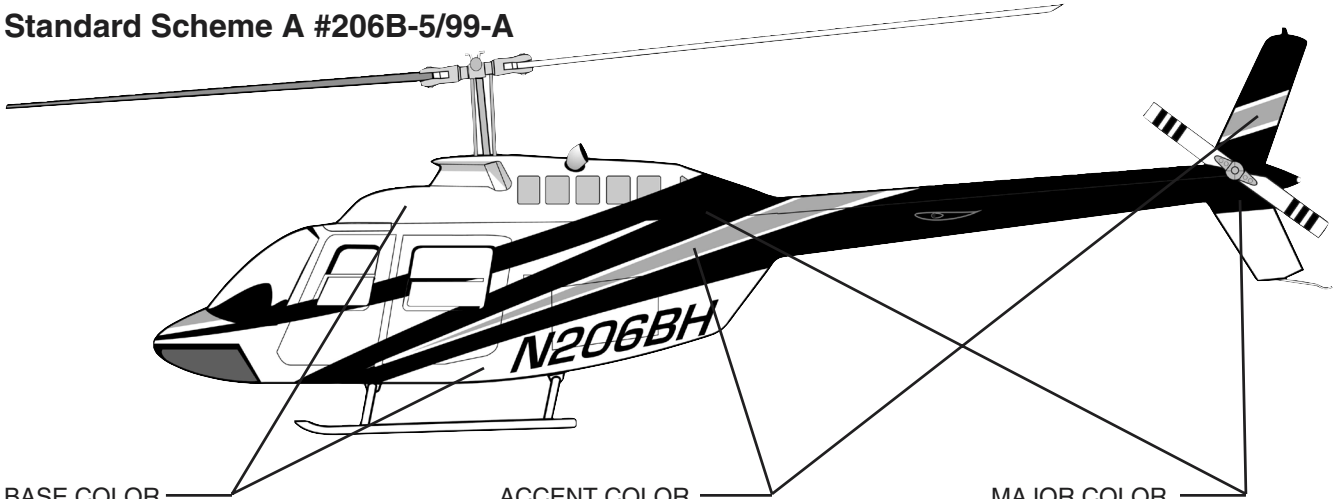

BASE COLOR _____	ACCENT COLOR _____	MAJOR COLOR _____
NAME _____	NAME _____	NAME _____
NUMBER _____	NUMBER _____	NUMBER _____

Standard Scheme B #206B-5/99-B

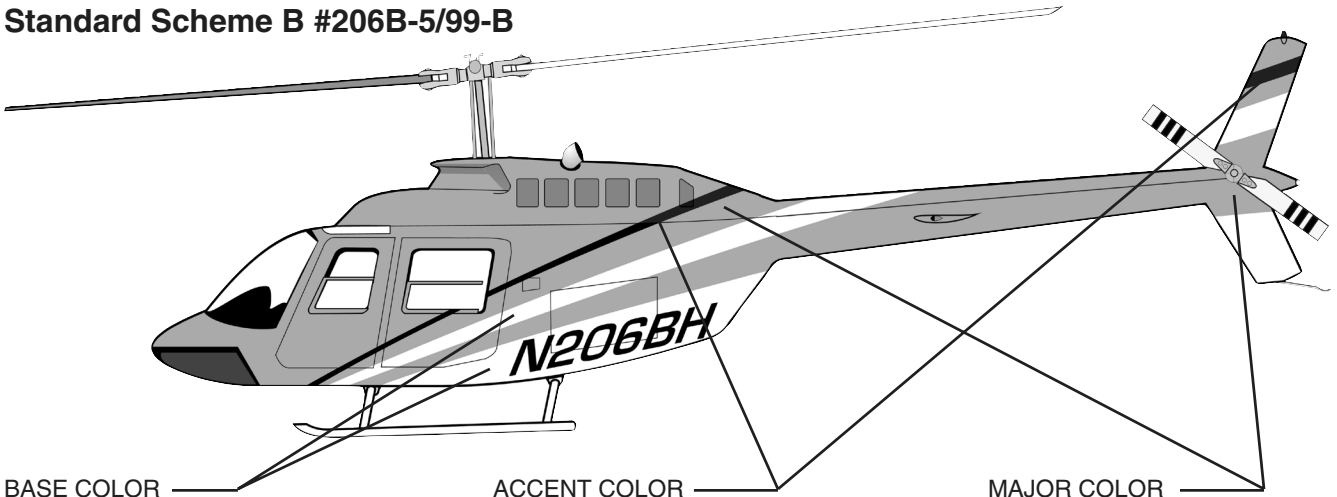

BASE COLOR _____	ACCENT COLOR _____	MAJOR COLOR _____
NAME _____	NAME _____	NAME _____
NUMBER _____	NUMBER _____	NUMBER _____

Standard Scheme C #206B-5/99-C

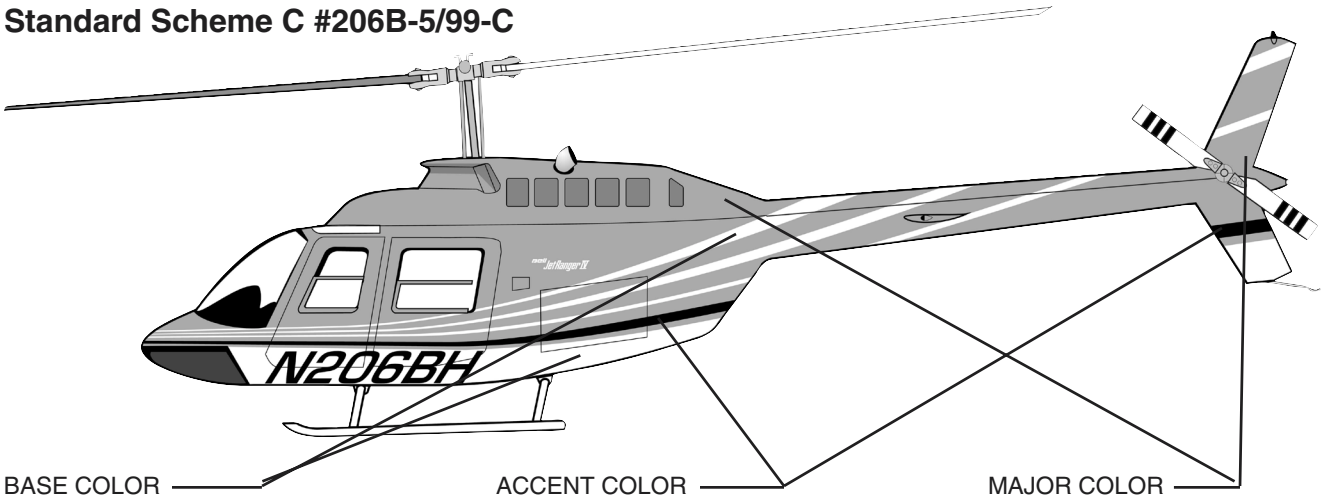

BASE COLOR _____	ACCENT COLOR _____	MAJOR COLOR _____
NAME _____	NAME _____	NAME _____
NUMBER _____	NUMBER _____	NUMBER _____

Custom Scheme

CUSTOMER _____
SERIAL NO. _____
REGISTRATION NO. _____

BEH 200B3

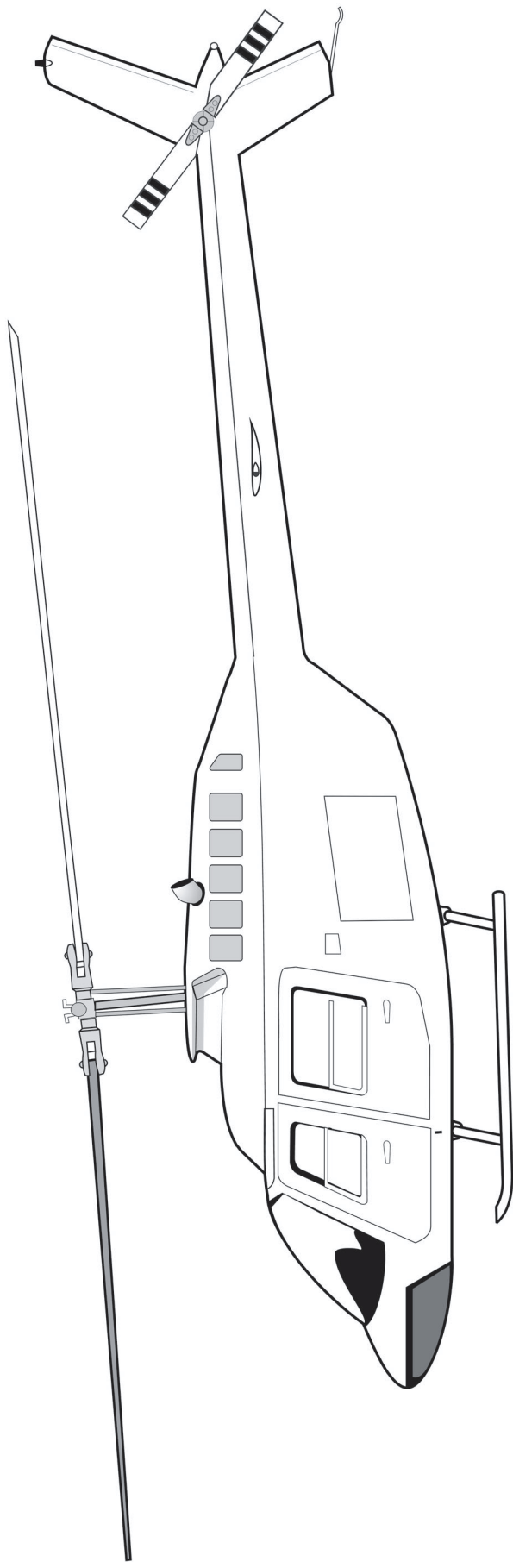

BASE COLOR
NAME _____
NUMBER _____

ACCENT COLOR
NAME _____
NUMBER _____

MAJOR COLOR
NAME _____
NUMBER _____

Bell 206B3

STANDARD PAINT SCHEMES COLOR SELECTION SAMPLES



A
206B3-5/99-A



B
206B3-5/99-B



C
206B3-5/99-C



A Textron Company

P.O. Box 482, Fort Worth, Texas 76101,
Phone: (817) 280-2800, Fax: (817) 278-2800
www.bellhelicopter.textron.com

**BELL HELICOPTER TEXTRON
DIVISION OF TEXTRON CANADA LTD.**
12,800 rue de l' Avenir Mirabel, Quebec, Canada J7J1R4
Phone: (450) 437-2729 Fax: (450) 437-2066

The data set forth in this brochure are general in nature and may vary with conditions. For performance data and operating limitations for any specific flight mission reference must be made to the approved flight manual.

Written, Edited and Layout by:
Dave Wyatt
817-280-6918
E-Mail Address: dwyatt@bellhelicopter.textron.com

© 2005 Bell Helicopter Textron Inc.
All Rights Reserved.
Printed in USA
January 2005